

# RIDE ON!

CLUB  2025

*ski-doo*

*LYNX*

*can-am*



*LYNX*

*ski-doo*

# MY 25 -WHAT'S NEW SNOWMOBILE ACCESSORIES

**COMMON**

# MY 25 – SNOWMOBILE STRATEGIC PRIORITIES

*LYNX.*  
*ski-doo.*

**1**

**Comfort: 1+1 seat improvements and better value**

**2**

**Utility: Doubling the storage capacity**

**3**

**Safety: Innovative signaling system now expanded to all models**

**4**

**Versatility: New compact seat and storage for Deep snow models**



# LINQ 1+1 REMOVABLE RACK ACCESSORY



## NEW VERSION

- TOOLESS, QUICK REMOVAL AND INSTALLATION! NEW DESIGN USES LINQ ATTACHEMENTS FOR THE RACK ITSELF.

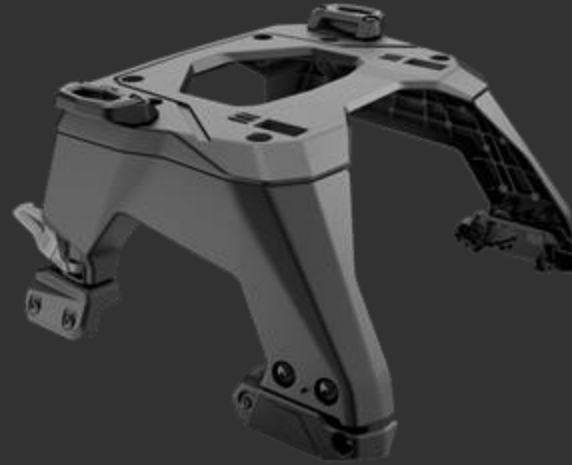

USE WITH

## PASSENGER SEATS

Trail LinQ Passenger Premium Heated Seat



Trail LinQ Passenger Premium Non-Heated Seat



Trail LinQ Passenger Seat



A MUST IF YOU'RE LOOKING TO USE A PASSENGER SEAT!

# PRICING STRATEGY ON 1+1 SEATS WITH NEW LINQ BASE

North America

- NEW PREMIUM SEAT – SAME FEATURES, NO HEAT, INCLUDED HANDGUARDS
- NEW QUICK REMOVABLE LINQ BASE, ALSO ALLOWS FOR POSITION 0.
- NEW LOWER PRICE ON FIXED 1+1 MOUNT BASE REDUCED TO \$199.99 FROM \$279.99 USD.

## Newest Premium Non-Heated Seat Retail Pricing VS Older 1+1 Premium Version



## Premium Heated Seat Retail Pricing

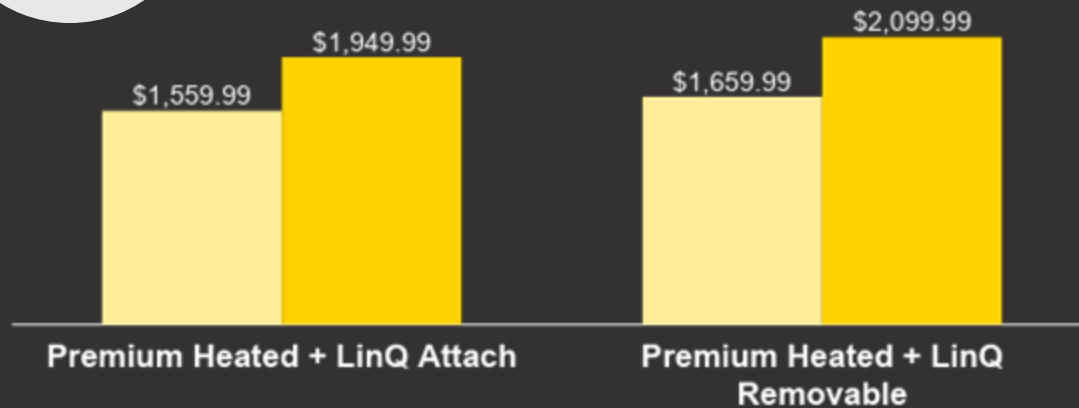

## Base Seat Retail Pricing

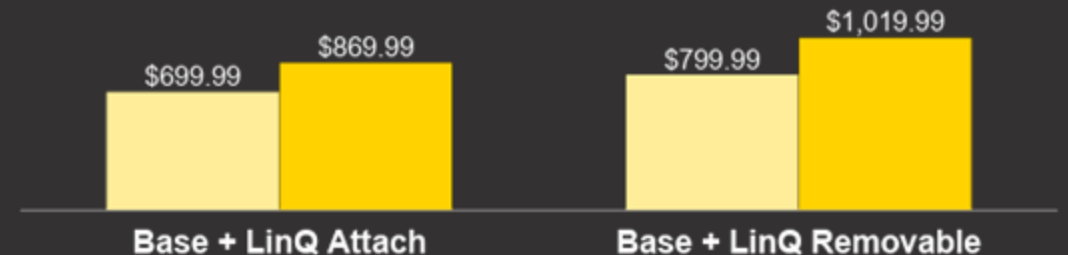

# LinQ 1+1 Removable Rack

**COMMON**

## Competitive Edge

NEW design uses LinQ attachments for the rack itself. A must if you're looking to use a passenger seat, the LinQ 1 + 1 Removable Rack looks great with or without a passenger seat on your sled. This snowmobile seat rack provides extra storage for LinQ accessories.

## Q&A

Will existing Rack still Exist? Yes, it is still available at a new lower price

## Features & Descriptions

- Quick, easy installation with LinQ system.
- Allows battery maintenance with the removable option.
- Required for LinQ Passenger Premium Heated Seat (860202536), Trail LinQ Passenger Sport Seat (860202917) and Trail LinQ Passenger Seat (860202325) use.
- Great look with or without the passenger seat mounted.
- Provides an additional LinQ position (for soft accessories only) when passenger seat isn't in use.
- Made of lightweight die cast aluminum.

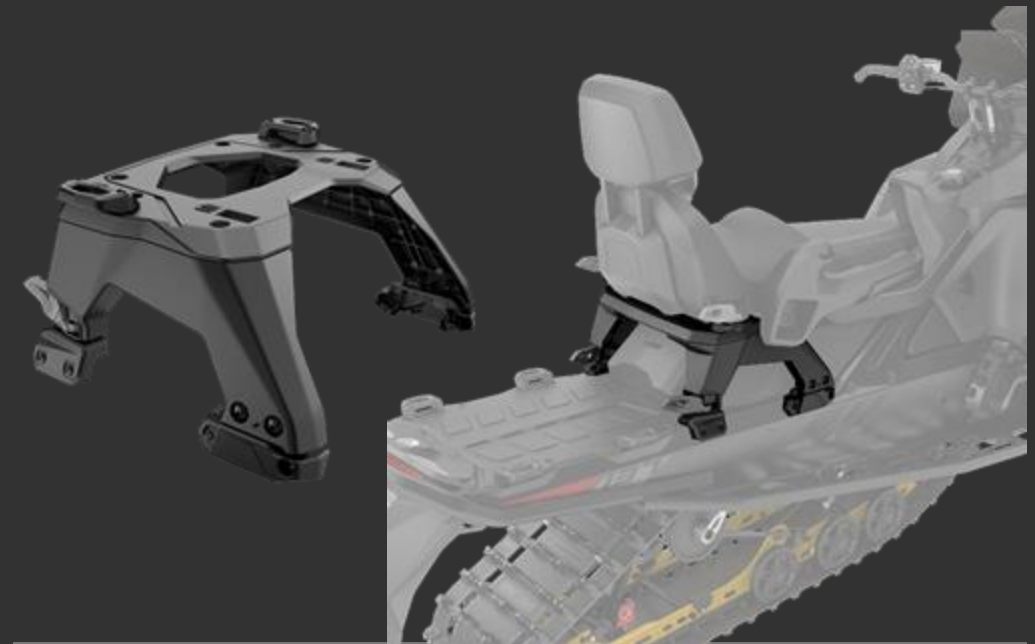

**SKU** : 860202749

**MSRP** : \$299.99 US / \$399.99 CA / 349 €

**Fits On** : REV Gen5 (except Grand Touring), REV Gen4 16" (except Grand Touring), Radien<sup>2</sup> , Radien, Radien-x 400mm (16") models

Lynx: Requires seat 860202782 or 510007704

**Installation time** : 45 min

**Margin** : 35%

**Availability** : August 2024

# Trail LinQ Passenger Premium Seat (Non-Heated)

**COMMON**

## Competitive Edge

Premium seat with lower price Consumer will now have 3 options. Premium Heated, Premium and Sport

## Q&A

Will old 1 piece style 1+1 style seat still exist.

No, with addition of LinQ removeable rack, and 3<sup>rd</sup> option of a trail seat we will no longer offer that model

## Features & Descriptions

- The ultimate modular seating solution.
- Quickly changes from riding solo to riding with a passenger.
- Provides comfortable, ergonomically correct positions for both driver and passenger.
- Compatible with LinQ locking system.
- Includes Passenger Backrest (860202659) and seat handles.
- Requires LinQ 1+1 Removable Rack (860202749) or LinQ 1 + 1 Rack (860202414 or 860202785) for installation.
- Requires Trail Wide Seat (860202523) or Trail Narrow Heated Seat (860202819) or Trail Narrow Seat (860202644) or Trail Wide Heated Seat (860202645) for installation on Summit, Freeride, Tundra, REV Gen4 Renegade (Enduro and Sport).
- Compatible with LinQ Passenger Seat Heated Grips (860202535).

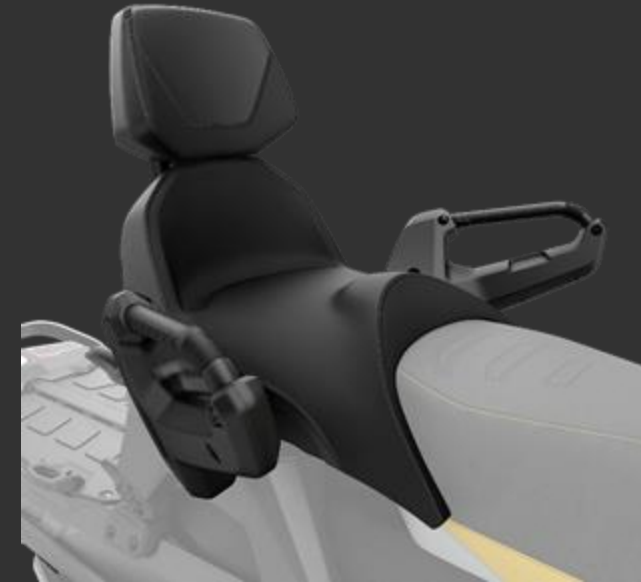

**SKU** : 860202917

**MSRP** : \$899.99 US / \$1159.99 CA / 1039 €

• **Fits On** : REV Gen5 (except Grand Touring), REV Gen4 16" (except Grand Touring) , Radien<sup>2</sup>, Radien, Radien-x 400mm (16") models

Lynx: Requires seat 860202782 or 510007704

**Installation time** : 5 min

**Margin** : 35%

**Availability** : October 2024



# LED SIGNAL LIGHTS FOR WINDSHIELD ACCESSORY

For medium and higher windshields

## 3 COLORS, 4 MODES, 1 GIANT LEAP

### HOW TO USE IT :

#### Mode 1 : WHITE

Default running light & esthetical signature.

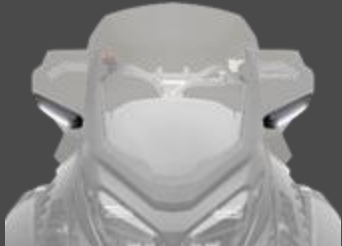

#### Mode 2 : AMBER (left only)

CAUTION! Rider(s) behind me.



#### Mode 3 : GREEN (left only)

BEWARE! Last sled in the group, or alone.



#### Mode 4 : AMBER (2x) FLASHING

CAUTION! Hazardous situation, or beware i've stopped.



WE NOW OFFER A SIGNALING SYSTEM FOR THE COMPLETE LINEUP OF REV GEN5 & RADIEN<sup>2</sup> BRP



# LED Signal Lights For Windshield

**COMMON**

## Competitive Edge

New innovative LED Signal Lights For Windshields provide style and have the potential to replace hand signals. With an integrated switch on the console, riders can access three colors and four modes to message approaching riders: White (default, no signal), Amber (riders behind), Green (solo/last rider) and Flashing Amber (caution).

## Q&A

Will it fit older models? Still TBD  
Will require wire harness  
8602002740 for Gen4 models

## Features & Descriptions

- LED Signal Light changes color.
- Includes a switch to change modes.
- Signals other riders on the trail.
  - Mode 1 white running light (default mode).
  - Mode 2 amber (left side only): Riders behind
  - Mode 3 green (left side only): Solo rider/end of group
  - Mode 4 both sides flash amber: Caution/hazardous situation
- Installs on Windshield Side Deflector Kit for medium and higher windshields.
- For easier installation, use the Accessory Switch Console with premade hole(860202827).
- Requires Windshield Side Deflector Kit (860202437) for medium and higher windshield if not already installed on your vehicle.
- Sold in pairs.

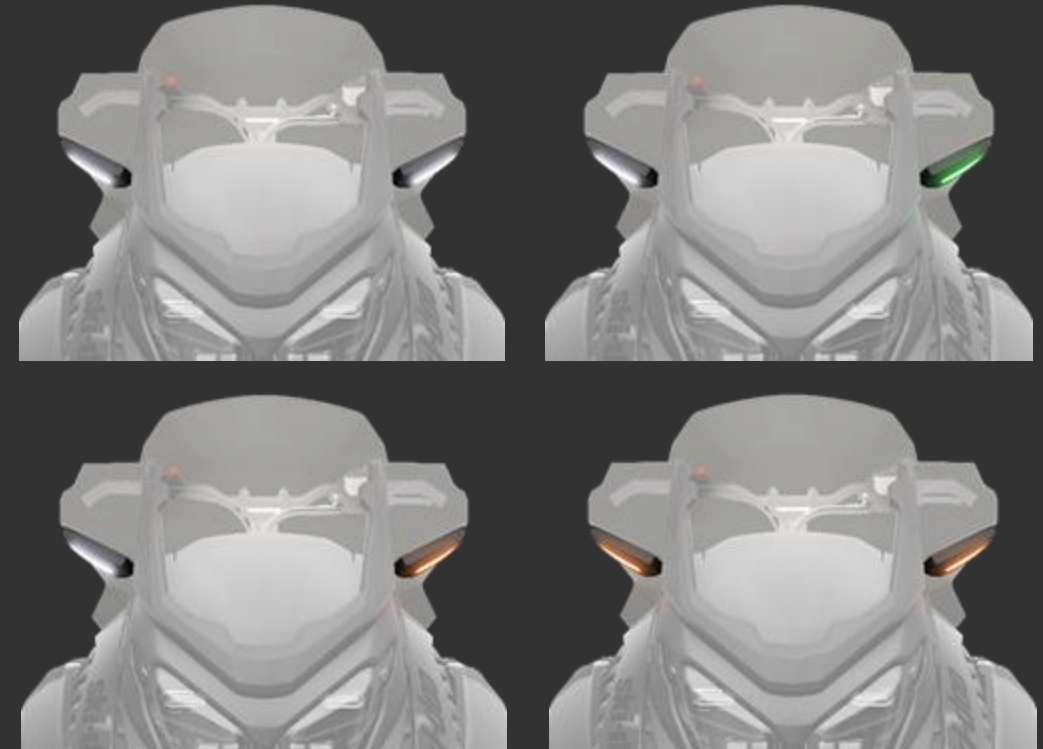

**SKU :** 860202703

**MSRP :** \$199.99 US / \$ 254.9 CA / 229 €

**Fits On :** REV Gen5 (Trail), Radien<sup>2</sup> (Trail)

**Installation time :** 60 min

**Margin :** 25%

**Availability :** August 2024

# Adjustable Windshield - High To Ultra High

**COMMON**

## Competitive Edge

This Adjustable Height Windshield provides maximum wind protection in the high position and lowers quickly for warmer days. Just flip the lever, slide and lock the lever to adjust for your perfect height in seconds.

## Q&A

## Features & Descriptions

- Adjustable range of 19" (47.5 cm) to 21" (53.5 cm)
- Single lever allows quick changes to the amount of wind protection.
- Injection molded for clarity and a better finish. • Compatible with Glove Box Extension (860202436).
- Compatible with Windshield-Mount Mirrors (860202679).
- Includes Windshield Support (517307974).
- Side Deflectors (860202437) required for installation.
- Not compatible with handguards and muffs.



**SKU :** 860202623

**MSRP :** \$ 299.99 US / \$ 389.99 CA / 349 €

**Fits On :** REV Gen5 (Trail, Crossover) Radien<sup>2</sup> (Trail)

**Installation time :** 15 min

**Margin :** 35%

**Availability :** August 2024

# Low Windshield-Dark Smoke

**COMMON**

## Competitive Edge

Find the right style and amount of wind protection for your ride with the Dark Smoke colored Low Windshield from BRP. At just 12.5" (32 cm) in height, it comes with a support and never hinders driving visibility. Pairs perfectly with Side Deflectors 860202849 for even more protection and style that blends perfectly.

## Q&A

Do we offer matching handguards. Yes, we have dark smoked handguards introduced 3 years ago. PN 860202474 for skidoo models

## Features & Descriptions

- Dark Smoke color.
- Low height – 12.5" (32 cm).
- Offers wind protection with integrated style.
- Injection molded for clarity and a better finish.
- Includes Windshield Support.
- Same shape and height as standard on MXZ X and Adrenaline models.
- Pairs perfectly with Windshield Side Deflector Kit (860202849).
- Compatible with handguards and muffs.



**SKU :** 860202850

**MSRP :** \$ 149.99 US / \$ 179.99 CA / 169 €

**Fits On :** REV Gen5 (Trail, Crossover) , Radien<sup>2</sup> (Trail)

**Installation time :** 10 min

**Margin :** 35%

**Availability :** August 2024

# Windshield Side Deflector Kit Dark Smoke

**COMMON**

## Competitive Edge

Get more protection from the wind and weather elements with our snowmobile Windshield Side Deflector Kit. Same Dark Smoke color as Low Windshield (860202850). For use with low or ultra low windshields for the perfect rides.

## Q&A

## Features & Descriptions

- Dark Smoke color.
- Added wind protection for use with low and ultra low height windshield.
- Compatible with Ultra Low Windshield (860202624) and Low Windshields (860202470, 860202850).



**SKU :** 860202849

**MSRP :** \$ 51.99 US / \$ 64.99 CA / 59 €

**Fits On :** REV Gen5 (Trail) for low and ultra low windshields, Radien 2 requires Windshield side deflector adapters 860202784

**Installation time :** 10 min

**Margin :** 35%

**Availability :** August 2024



# LinQ Saddlebags - 23 L

**COMMON**

## Competitive Edge

These ultra-stylish looking LinQ Saddlebags are made of a premium semi-rigid material and offer an extra six gallons (23-liter, 1403 cu in) of cargo capacity to extend your ride even further. The bright yellow interior makes locating items easier and the water-resistant construction keeps cargo dry. They mount to the side of the tunnel and because they don't use the LinQ tunnel mounts - there's no interference with other LinQ accessories.

## Q&A

Do these attach better than old saddle bags. Yes, utilizing new vertical LinQ tunnel bracket and lower section of bags are protected by the tunnel

## Features & Descriptions

- Premium semi-rigid saddlebags use an independent LinQ mounting system.
- Installed further forward than Position 1.
- Easy attachment and removal.
- Can be used in conjunction with additional LinQ mounted accessories at the same time.
- 6 US gallon (23-liter, 1403 cu in) total capacity.
- Brightly colored yellow interior makes it easy to locate objects.



**SKU :** 860202621

**MSRP :** \$339.99 US / \$434.99 CA / 339 €

**Fits On :** REV Gen5 (except Grand Touring), REV Gen4 16" (except Grand Touring), Radien<sup>2</sup>

**Installation time :** 30 min

**Margin :** 35%

**Availability :** August 2024

# Underseat Storage Bag - 11 L

**COMMON**

## Competitive Edge

The Underseat storage bag fits perfectly in the space below the seat of Expedition and Skandic Widetrack and Super Widetrack models. The durable polyester construction is insulated to protect from cold while the integrated handles make removal and installation easy.

## Q&A

## Features & Descriptions

- Installs inside the 4 US gallon (15-liter, 915 cu in) underseat storage that comes stock on 20" and 24" models.
- 3 US gallon (11-liter, 671 cu in) capacity
- Insulated to protect from outside temperatures.
- Durable polyester construction.
- Integrated handles make transportation easy.

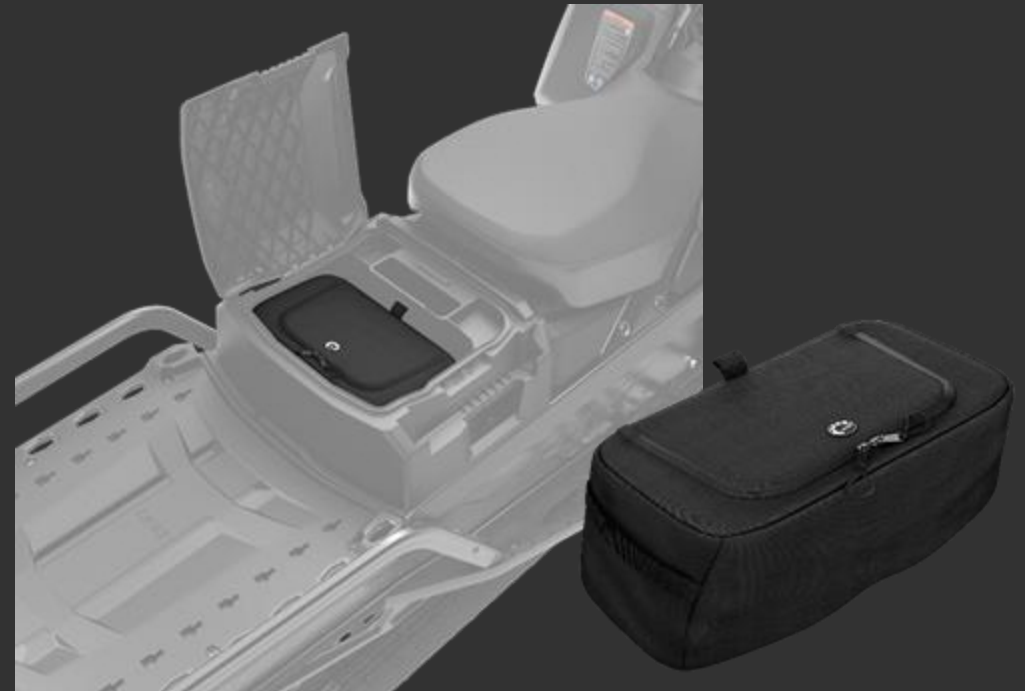

**SKU :** 860202767

**MSRP :** \$99.99 US / \$ 129.99 CA / 99 €

**Fits On :** REV Gen4 & Radien-X (Wide) 20" and 24"

**Installation time :** 5 min

**Margin :** 35%

**Availability :** August 2024

# Embedded Maps

**COMMON**

## Competitive Edge

Update a 10.25" Color Touchscreen Display with embedded maps and GPS tracking so riders can see their position at all times.

## Q&A

Is this retrofittable? Yes, it Fits MY 23 & 24 specifically. It is including on all MY 25 10.25" gauges

## Features & Descriptions

- Retrofit for 2023 and 2024 vehicles with a 10.25" Color Touchscreen Display.
- Adds GPS tracking.
- Adds embedded maps.
- Allows GPS mapping and tracking without a cell phone.
- Included on all 2025 models with 10.25 in. Color Touchscreen Display.
- A software update will be required to use the built-in navigation features.



**SKU :** 860202727

**MSRP :** \$79.99 US / \$ 99.99 CA / 129 €

**Fits On :** REV Gen5 Radien<sup>2</sup> 2023 and up with 10.25" Color Touchscreen Display.

**Installation time :** 30 min

**Margin :** 25%

**Availability :** October 2024

# Fixed Riser - 2.8" (70 mm)

**COMMON**

## Competitive Edge

Fine tune your ride by choosing the 2.8" (70 mm) Fixed Riser to better fit your riding style. This is our shortest height offering.

## Q&A

## Features & Descriptions

- 2.8" (70 mm) height.
- Lightweight machined aluminum construction.

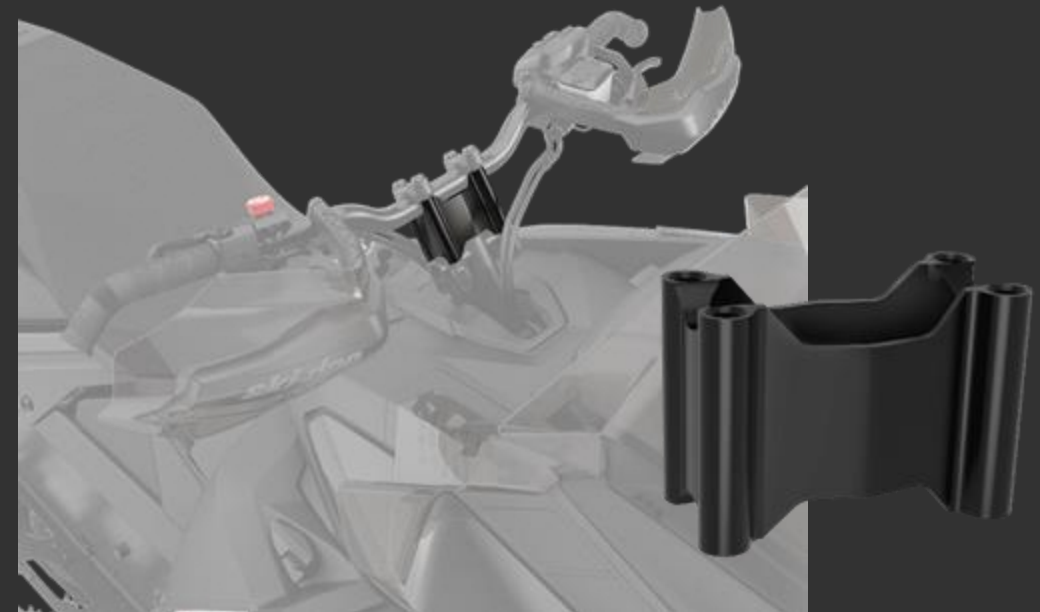

**SKU :** 860202859

**MSRP :** \$ 54.88US / \$ 69.99 CA / 64 €

**Fits On :** REV Gen5, REV Gen4,Radien2, Radien,  
Radien-X

**Installation time :** 20 min

**Margin :** 35 %

**Availability :** August 2024



# Woody's Slim Jim 2.0 Dooly™

**COMMON**

## Competitive Edge

Aggressive dual runner design compatible with most pilot skis that eliminates darting and penetrates deep for maximum cornering ability.

## Q&A

Does this product use Woody's packaging?

Yes, it does

## Features & Descriptions

- Aggressive dual runner design that eliminates darting and penetrates deep for maximum cornering ability.
- Available in 4-8" of cutting carbide per host bar to accommodate un-studded to heavily studded snowmobiles.
- Hard weld is also added in high wear areas to prolong runner life.
- Sold individually.
- Performance : 4, Ease of steering : 1, Longevity : 3

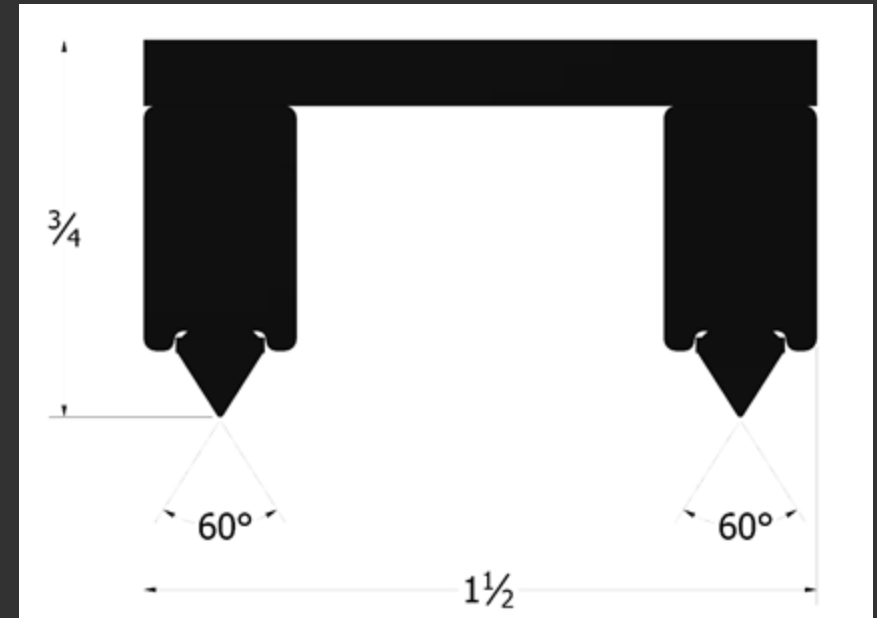

**SKU :** 860202776 - 4", 860202923 - 6"

**MSRP :** \$ 95.99 US / \$124.99 CA / 109 € - 4"

**MSRP :** \$ 117.99 US / \$154.99 CA / 139 € - 6"

**Fits On :** Blade, All Pilot Skis except Pilot 5.7 SL

**Installation time :** 30 min

**Margin :** 35%

**Availability :** August 2024

***ski-doo***<sup>®</sup>

**What's New Accessories**



CLUB  2025

# RAS RX Front Suspension

## Competitive Edge

Conquer the most challenging trail conditions with unbreakable confidence with RAS RX Front Suspensions.

## Q&A

## Features & Descriptions

- Provides better cornering stability and steering precision.
- The taller ski leg and the new geometry are inspired by the RAS-RS.



**SKU :** 860202843

**MSRP :** \$719.99 US / \$929.99 CA / 829 €

**Fits On :** REV Gen5 and REV Gen4 with RAS X front suspension and 42" ski stance (except Grand Touring)

**Installation time :** 120 min

**Margin :** 35%

**Availability :** October 2024

# DEEP SNOW ACCESSORY NOVELTIES



## Deep Snow Ultra-Light Seat

### MAIN FEATURES

- SMALL, COMPACT SHAPE FOR FREEDOM OF MOVEMENT.
- SEAMLESS DESIGN WITH LESS STITCHING MINIMIZES CHANCES OF WATER INTRUSION.
- IMPROVED FRONT CLIP SEALS FOR BETTER MOISTURE RESISTANCE.

CVT Belt storage compartment

Grip pattern with brand logo

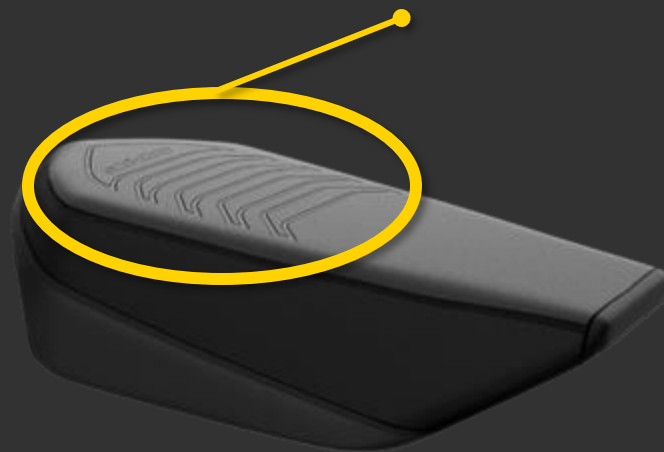

**Store a CVT belt under your seat and never look back!**

\*specific sku for Lynx and Ski-Doo

## Soft Glovebox Extension

Now available on REV Gen5 & Radien<sup>2</sup>



- INCREASES STOCK STORAGE VOLUME BY ABOUT 30%.
- WATER RESISTANT.
- INCLUDES AN INSIDE CELL PHONE POUCH.

\*specific sku for Lynx and Ski-Doo



# DEEP SNOW ACCESSORY NOVELTIES

## Deep Snow Ultra-Light Seat

### MAIN FEATURES

- SMALL, COMPACT SHAPE FOR FREEDOM OF MOVEMENT.
- SEAMLESS DESIGN WITH LESS STITCHING MINIMIZES CHANCES OF WATER INTRUSION.
- IMPROVED FRONT CLIP SEALS FOR BETTER MOISTURE RESISTANCE.

CVT Belt storage compartment

Grip pattern with Ski-Doo logo

Store a CVT belt under your seat and never lookback!

\*specific sku for Lynx and Ski-Doo

## Soft Glovebox Extension

Now available on REV Gen5 & Radien<sup>2</sup>

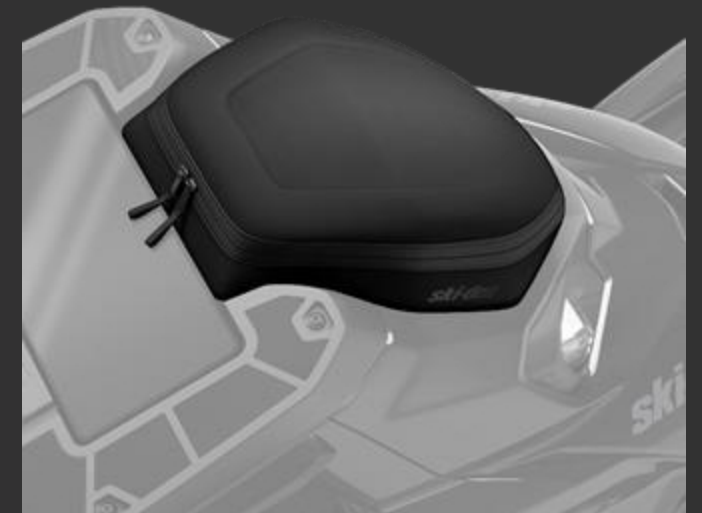

- INCREASES STOCK STORAGE VOLUME BY ABOUT 30%.
- WATER RESISTANT.
- INCLUDES AN INSIDE CELL PHONE POUCH.

\*specific sku for Lynx and Ski-Doo

# Deep Snow Ultra-Light Seat

## Competitive Edge

NEW Ultra-Light Deep Snow Seat offers a small shape for easy movement with an integrated CVT belt storage area underneath. The seamless cover and redesigned base better protect from water intrusion with less stitching and a new front clip area that better seals moisture out.

## Q&A

## Features & Descriptions

- Small, compact shape for freedom of movement.
- Seamless design with less stitching minimizes chances of water intrusion. • Improved front clip seals for better moisture resistance. Doesn't absorb water
- 290 grams lighter than stock x with belt cover
- Underseat storage compartment for CVT belt.
- Works with Seat Storage Box - 6 L (860202532). • 127 mm (5") height.
- Overall weight reduction of X lbs

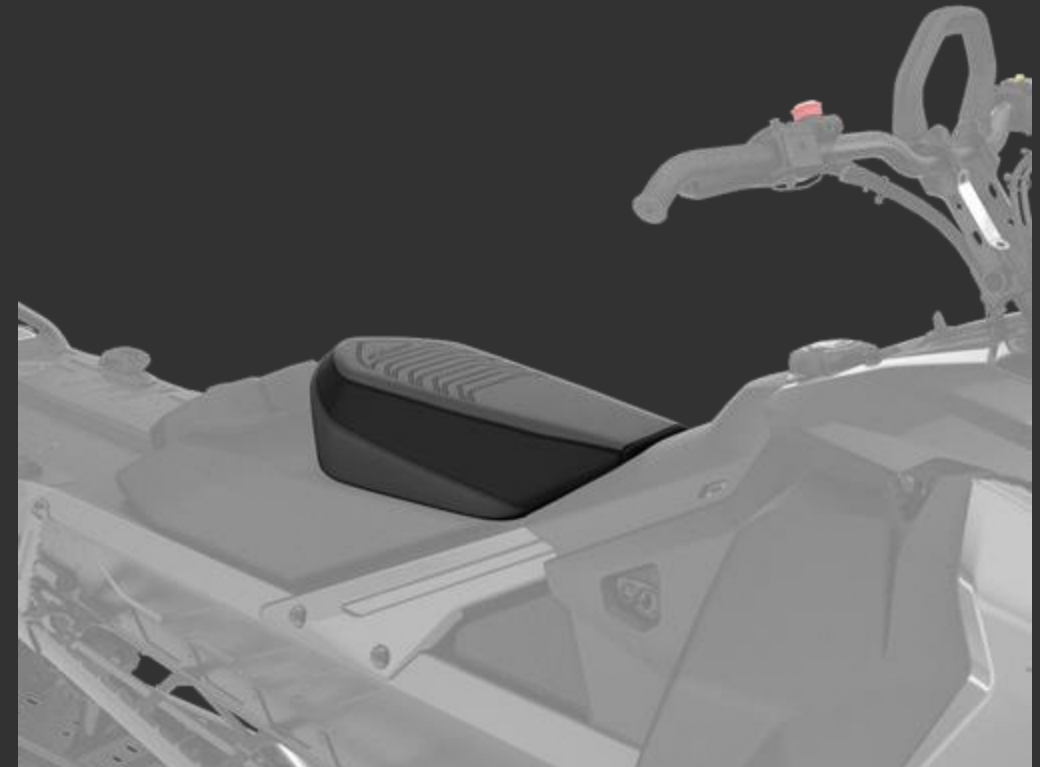

**SKU :** 860202775

**MSRP :** \$349.99 US / \$454.99 CA / 399 €

**Fits On :** REV Gen5 16", REV Gen4 16"

**Installation time :** 5 min

**Margin :** 35%

**Availability :** August 2024

# Soft Glove Box Extension

## Competitive Edge

Add some easily accessible storage with the Soft Glove Box Extension. The semi-rigid construction is durable and water resistant while adding 30% more capacity, including a separate inner cell phone compartment. The bright yellow interior makes it easier to spot items and offers more protection to the things inside. Works with USB and 12 Volt power outlets and the Low windshield.

## Q&A

Is this similar to the very popular glove box extension on G4 Deep snow?

Yes, it is, however it is a new version to match the specific fit of G5 DS

## Features & Descriptions

- Increases stock storage volume by about 30%.
- 1.3 US gallon (4.8-liter, 293 cu in) capacity.
- Easier on your personal items than the stock glovebox.
- Can be used with or without Low Windshield (860202602).
- Brightly colored yellow interior makes it easy to locate objects.
- Water resistant.
- Includes an inside cell phone pouch.
- Compatible with USB Intelligent Power Outlet Kit (860202433) and 12-Volt Power Outlet Kit (860201423).
- Easy installation by removing the stock glovebox lid.



**SKU :** 860202857

**MSRP :** \$ 189.99 US / \$ 229.99 CA / 179 €

**Fits On :** REV Gen5 (Deep Snow)

**Installation time :** 15 min

**Margin :** 35%

**Availability :** August 2024

# Deep Snow Extreme Skid-Plate

## Competitive Edge

The Extreme Skid Plate is for those deep snow riders that want extra chassis protection with minimal weight added. The narrow design doesn't hold snow while still covering those critical parts if an unforeseen obstacle is encountered.

## Q&A

## Features & Descriptions

- Injection molded process provides smooth surface, better definition, a perfect fit and easier installation.
- For assertive riders who demand the ultimate protection.
- Smooth bottom surface to reduce drag.
- 4-mm thick, high impact resistance polypropylene for durability.
- Attachment kit included.
- Chassis is premarked for easy installation.

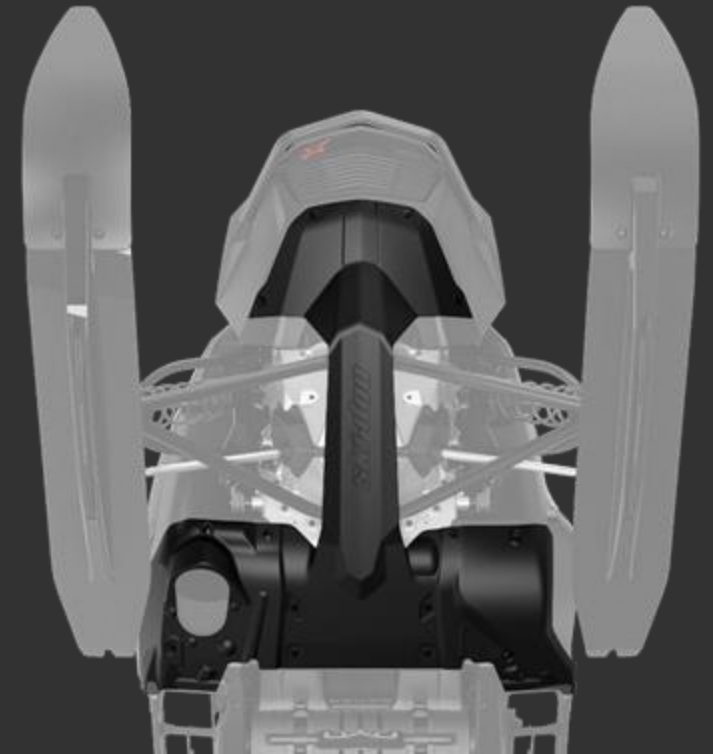

**SKU :** 860202851

**MSRP :** \$ 159.99 US / \$ 194.99 CA / 179 €

**Fits On :** REV Gen5 (Deep Snow)

**Installation time :** 30 min

**Margin :** 35%

**Availability :** August 2024

# Trail Narrow Heated Seat

## Competitive Edge

Add Ski-Doo's heated snowmobile seat on your ride and laugh at the coldest conditions winter can throw at you. These days, heated seats have become a common feature on many sleds and for good reason, comfort! With High/Low/OFF settings, you'll always find the perfect temperature for your ride whenever you need it.

## Q&A

## Features & Descriptions

- Adds warmth in the coldest conditions.
- High/Low/Off settings.
- Narrow shape at front for freedom of movement.
- Excellent support for trail riding.
- Easy toolless installation.
- Compatible with Trail LinQ Passenger Premium Heated Seat(860202536), Trail LinQ Passenger Sport Seat (860202917) and Trail LinQ Passenger Seat (860202325).
- Requires Retrofit Harness (860202740) for installation on REV Gen4 models.

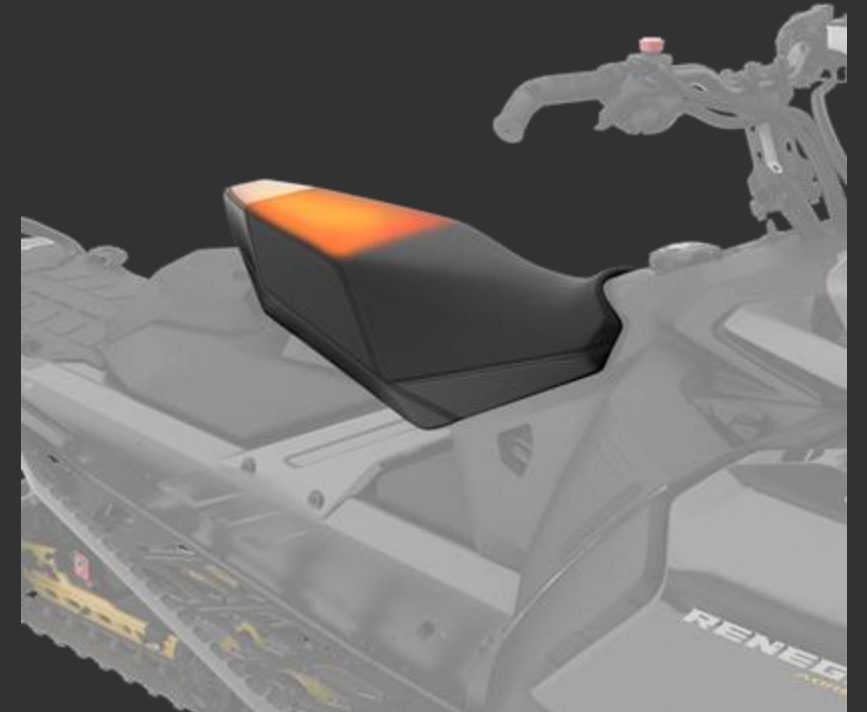

**SKU :** 860202819

**MSRP :** \$ 579.99 US / \$749.99 CA / 669 €

**Fits On :** REV Gen5 (except Grand Touring), REV Gen4 16" (except Grand Touring)

**Installation time :** 30 min

**Margin :** 35%

**Availability :** August 2024



# STACKABLE LINQ DECK ACCESSORY

## MAIN FEATURES

- CARRIES UP TO 50 LBS (22 KG) OF GEAR BY DUPLICATING POSITION 1 AND 2 OF THE TUNNEL AREA.
- LEVER OPERATED LATCH OPENS / CLOSE THE DECK.
- EQUIPPED WITH A GAS STRUT THAT HOLDS THE DECK OPEN FOR EASY ACCESS TO CARGO UNDERNEATH.

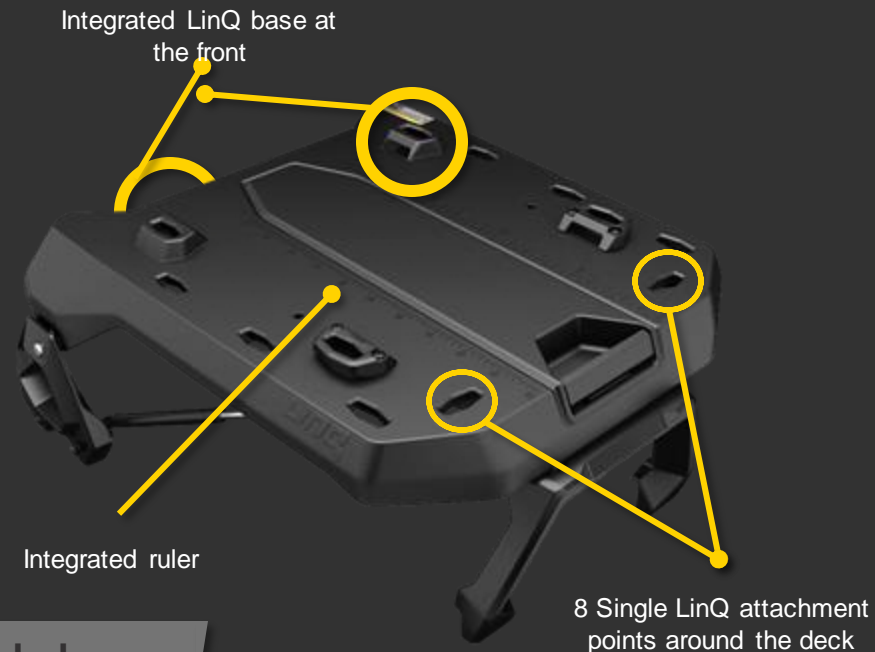

For 20" and 24" sleds



# Stackable LinQ Deck

## Competitive Edge

Level up and double your storage with the Stackable LinQ Deck. Carries up to 50 lbs. (22 kg) of gear by duplicating positions 1 & 2 of the tunnel area 14,75" (37.5 cm) above it. The composite construction uses steel, aluminum and polypropylene in a robust design for long life. When the secure latch system is released, the deck is held open by a gas strut for easy access to the cargo below it. Depending on seat configuration - accessories can be left on the deck when opening.

## Features & Descriptions

- Doubles the LinQ mounting surface area of the tunnel positions 1 and 2.
- Top deck maximum weight capacity : 50 lbs (22 kg), total tunnel weight capacity with Stackable LinQ Deck installed : 100 lbs (44 kg).
- Steel and aluminum structure is covered with polypropylene for long life.
- Eight LinQ attachment points for single mount accessories like LinQ Tool holder (860201846) and LinQ working Light (860202380).
- Lever operated latch opens / closes the deck.
- Reinforcement kit included to give extra protection to the Cargo Rack Kit.
- Equipped with a gas strut that holds the deck open for easier access to cargo underneath.
- Ability to leave equipment installed on the top deck when there is no passenger seat installed.
- Requires installation of Cargo Rack Kit (860202245) for Expedition Xtreme and Skandic Sport.
- We recommend stiffer rear suspension springs when installing the Stackable LinQ Deck.



**SKU :** 860202746

**MSRP :** \$ 599.99 US / \$ 799.99 CA / 689 €

**Fits On :** REV Gen4 (Wide) 20" and 24"

**Installation time :** 90 min

**Margin :** 35%

**Availability :** August 2024

# Widetrack 2-up Seat With Small Handles

## Competitive Edge

This Widetrack 2-up Seat delivers an economical solution to adding room for a passenger and offers smaller, less intrusive handles to get on and off the snowmobile easier.

## Q&A

Lower price pt than current version

## Features & Descriptions

- Passenger seat to transform into a 1 + 1 configuration.
- Includes smaller safety handles for a good grip and easier on/off.
- Passenger Backrest (860202036) can be added for more comfort.
- Standard on REV Gen4 Skandic LE models.



**SKU :** 860202824

**MSRP :** \$699.99 US / \$ 899.99 CA / 809 €

**Fits On :** REV Gen4 & Radien-X (Wide) 20" and 24"

**Installation time :** 5 min

**Margin :** 35%

**Availability :** October 2024

# Utility Soft Knee Pads

## Competitive Edge

Add a little protection, comfort and grip for your knees with these specially designed pads. The flexible material absorbs impact, and they install easily.

## Q&A

Is this the same material as what was introduced on DS and Trail G5 models last year? Yes, same product different shape for perfect panel fit

## Features & Descriptions

- Fit perfectly on 20" and 24" Ski-Doo models.
- Provide comfort, impact absorption and extra knee grip.
- Made with a flexible injection molded material.
- Easy-to-install Christmas tree type fasteners.

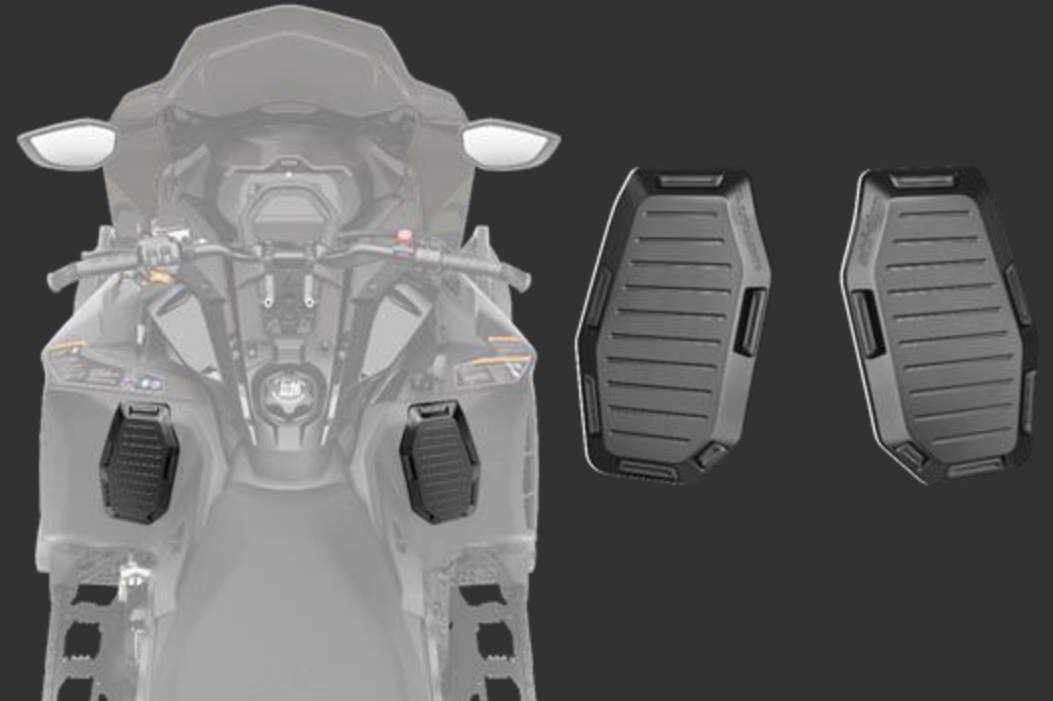

**SKU :** 860202852

**MSRP :** \$89.99 US / \$109.99 CA / 104 €

**Fits On :** REV Gen4 (Wide) 20" and 24"

**Installation time :** 15 min

**Margin :** 35%

**Availability :** August 2024

# LYNX<sup>®</sup>

## What's New Accessories

CLUB  2025





# LYNX MY25 – WHAT'S NEW ACCESSORIES

NOT ALL THE PRODUCT NEWS ARE AVAILABLE IN NORTH AMERICA. THE ONES THAT ARE AVAILABLE, HAVE BEEN MARKED WITH FLAG SIGN



# Magnetic Spare Lens Holder

## Competitive Edge

Safeguard your Radien Magnetic Goggle Spare Lenses during rides, ensuring quick and secure attachment with its magnetic feature in just seconds.

## Features & Descriptions

- Attaches securely to the cover of the Glove Box, ensuring convenient access
- Comes equipped with a dedicated cover to safeguard your lenses during storage
- Simply plug and play with a few screws and premarked drill locations for effortless setup
- Two lenses can be easily attached to the holder.
- Glovebox extension (860202436, 860202596) required



**SKU:** 860202868

**MSRP:** 149,00 €

**Fits On:** Radien<sup>2</sup> , Radien, Radien-X

**Installation time:** 15 min

**Margin :** 35 %

**Availability :** November 2024

# Wide Beam Auxiliary Lights - Trail models



## Competitive Edge

These Auxiliary lights offer improved side visibility, providing a wider view of the trail for the unit. Additionally, a fully integrated lighting system ensures illumination even during the polar night.

## Features & Descriptions

- Provide a wider and more consistent light pattern
- Covers the dark zone directly in front of the vehicle and to the sides for more pleasant riding
- LED lights add 2,000 additional lumens in an intense, super-wide foglight-type pattern
- Complete stock lighting with a next level integration and nice look
- Easy to install with a simple plug-and-play hook-up
- Always on, no switch.



**SKU:** 860202715

**MSRP:** \$ 359.99 US / \$439.99 CA / 419 €

**Fits On:** Radien<sup>2</sup> Trail Models

**Installation time:** 20 min

**Margin :** 25%

**Availability :** August 2024

# Thermosbottle Holder

## Competitive Edge

Experience peace of mind while carrying your favorite warm drinks or meals with the Thermos Bottle Holder, designed to keep your refreshments safe, secure, and readily accessible during your adventures

## Features & Descriptions

- Perfect companion for transporting warm beverages or food securely in your seatbox
- Effortless installation, and the cover securely locks the thermos in place
- Holder includes one thermos bottle, and there's an extra space available for a second one of your choice
- The bottle meets stringent food safety standards

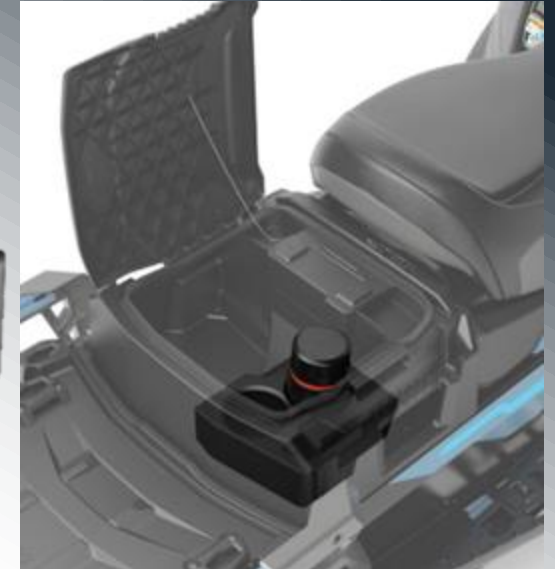

**SKU:** 860202731

**MSRP:** 79,00 €

**Fits On:** Radien-X 500mm (20") and 600 mm (24") (except Alpine models)

**Installation time:** 5 min

**Margin :** 30%

**Availability :** September 2024

# Soft Glovebox Extension



## Competitive Edge

Made from semirigid material, this upgrade enhances both convenience and aesthetics for your mountain vehicle. Plus, the addition of a soft glove box boosts the stock storage volume by approximately 30%

## Features & Descriptions

- Generous 4.8 Liter capacity
- Lynx **Red** Interior, making it effortless to locate items inside
- Water-Resistant Design
- Integrated Cell Phone Pouch
- Compatible with the USB Intelligent Power Outlet Kit (860202433) and 12-Volt Power Outlet Kit (860201423) for added functionality
- Easily installed by removing the stock glovebox lid and using the existing fastening points



**SKU:** 860202908

**MSRP:** \$189.99 US / \$229.99 CA / 179 €

**Fits On:** Radien<sup>2</sup> Deep Snow

**Installation time:** 15 min

**Margin :** 35 %

**Availability :** August 2024



# Deep Snow Ultra-Light Seat



## Competitive Edge

The Ultra-Light Deep Snow Seat provides effortless movement with a compact shape and convenient CVT belt storage below. Its seamless cover, redesigned base, and improved front clip effectively protect against water intrusion with minimal stitching, keeping moisture and added weight out.

## Features & Descriptions

- Small, compact shape for freedom of movement.
- Seamless design with less stitching minimizes chances of water intrusion
- Improved front clip seals for better moisture resistance
- Underseat storage compartment for CVT belt
- Works with Seat Storage Box - 6 L (860202532).
- 127 mm (5") height

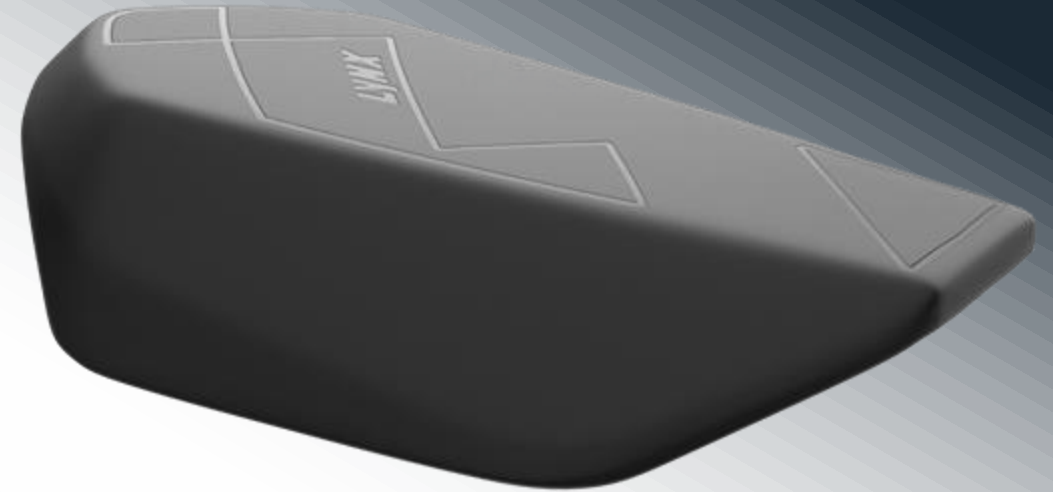

**SKU:** 860202909

**MSRP:** \$349.99 US / \$454.99 CA / 399 €

**Fits On:** Radien<sup>2</sup>, Radien

**Installation time:** 5 min

**Margin :** 35 %

**Availability :** August 2024

# Heavy Duty Bumper - Light Utility 400 mm

## Competitive Edge

With this heavy-duty bumper, tackle the trail or off-trail with confidence, knowing that your sled is equipped with the ultimate front-end defense.

Bumper adds a touch of attitude and style to your sled's appearance.

## Q&A

**Q:** Is an additional HD bumper necessary for installing this new bumper?

**A:** No, it is not. Unlike the earlier model, the new bumper is ready for installation without any extra bumper.

## Features & Descriptions

- Designed with utility in mind
- Tailored for Radien<sup>2</sup> platform and 49 Ranger
- Pre-marked attachment points
- Heavy protection without compromising on lightweight construction
- Durable steel construction



**SKU:** 860202817

**MSRP:** 349,00 €

**Fits On:** Radien<sup>2</sup> Trail Models

**Installation time:** 45 min

**Margin :** 35 %

**Availability :** August 2024

# Fullbody Skidplate – Radien<sup>2</sup> 4-stroke models



## Competitive Edge

Skidplate featuring our new, easy assembly attachment kit for faster installation.

Get maximum, extra-wide protection designed for demanding conditions.

## Features & Descriptions

- Previously identified by SKU 860202343, has been upgraded to the new SKU 860202912
- Full coverage skid including chaincase and brake disk protection
- Injection molded assures a perfect fit and easy installation.
- Attachment kit included for easy assembly without the need for disassembly.

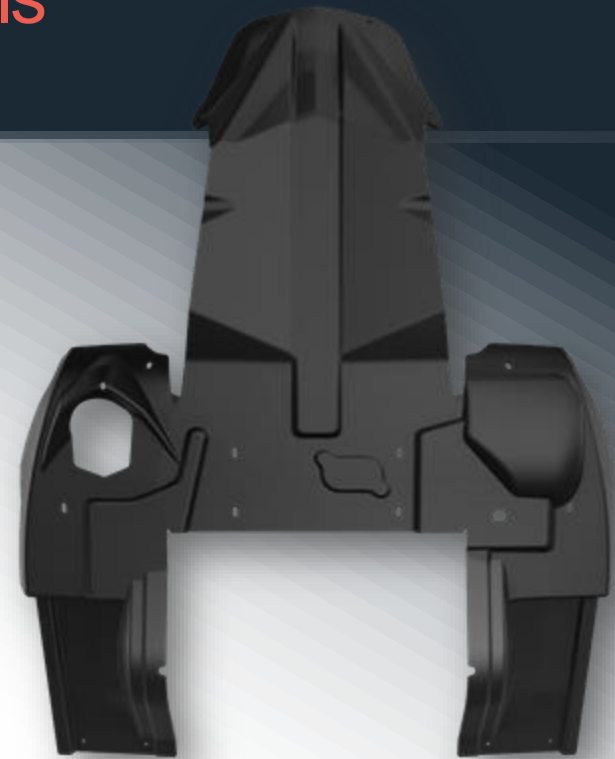

**SKU:** 860202912

**MSRP:** 219,00 €\*

**Fits On:** Radien<sup>2</sup> 4-stroke models

**Installation time:** 30 min

**Margin :** 35 %

**Availability :** August 2024

(\*€ inc. VAT)

# Suspension Upgrade kit - 996 mm and EasyRide+

## Competitive Edge

Take over suspension package from Lynx Commander RE and Brutal models. High performance Suspension packages with 3-step compression and rebound adjustment.

## Features & Descriptions

### Front kit

- Suitable for 996 mm (39") ski stance
- Include two pieces of KYB PRO 36 EA-3 R Kashima shocks with 3-step compression and rebound adjustment
- Full kit which includes shocks, springs and installation hardware
- Retrofittable Radien-X 996 mm ski stance

### Rear kit

- Suitable for EasyRide+ rear suspension
  - Rear Shock KYB PRO 46 EA-3 R Kashima with 3-step compression and rebound adjustment
  - Center Shock KYB 46 PLUS Kashima maintainable
  - Full kit which includes shocks, springs and installation hardware
  - Retrofittable with EasyRide
- Suspension packages recommended especially for Commander STD and LTD



**SKU:** 860202879 (Front) , 860202913 (Rear)

**MSRP:** 1 199 € (Front), 1 299 € (Rear)

**Fits On:** Radien-X (Commander, 59 Ranger, 69 Ranger models)

**Installation time:** 60 min

**Margin :** 35 %

**Availability :** August 2024

# Shock upgrade kit - 921mm and 864 mm and PPS<sup>2</sup> DS

## Competitive Edge

Suspension package recommended especially for 49 Ranger

High performance Suspension packages with 3-step compression and rebound adjustment.

## Features & Descriptions

### Front kit

- Suitable for 921mm (36") and 864 mm (34") ski stance
- Includes two Shocks; KYB PRO 36 EA-3 R Kashima shocks with 3 step compression and rebound adjustment
- Full kit which includes shocks, springs and installation hardware

### Rear kit

- Suitable for PPS<sup>2</sup> DS rear suspension
- Rear Shock KYB PRO 46 EA-3 R Kashima with 3-step compression and rebound adjustment
- Center Shock KYB 46 PLUS Kashima maintainable
- Full kit which includes shocks, springs and installation hardware



**SKU:** 860202877 (Front) , 860202914 (Rear)

**MSRP:** 1 199 € (Front), 1 299 € (Rear)

**Fits On:** Radien<sup>2</sup> (49 Ranger)

**Installation time:** 60 min

**Margin :** 35 %

**Availability :** August 2024



# Rail Reinforcements

## Competitive Edge

Enhance the strength and durability of your EasyRide+ rear suspension.

## Features & Descriptions

- Increases rail strength and longevity
- Specific for EasyRide+ rear suspension
- Standard on Brutal and Commander RE models

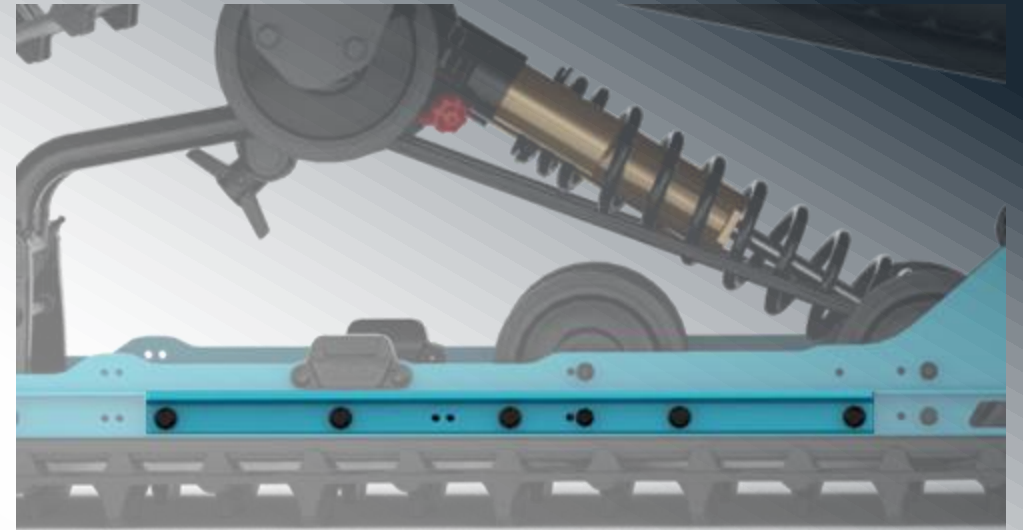

**SKU:** 860202795

**MSRP:** 99,00 €

**Fits On:** Radien-X 500 mm & 600 mm EasyRide+

**Installation time:** 20 min

**Margin :** 35 %

**Availability :** August 2024

# Ice Scratchers 600 mm

## Competitive Edge

The Ice Scratchers, now available for 24" models. These scratchers offer crucial additional lubrication, particularly in tough and icy conditions, ensuring optimal performance on the trail.

## Features & Descriptions

- Compact and lightweight, these scratchers are rail-mounted for easy installation and minimal added weight
- Coil design allows for reversing without causing any damage, offering peace of mind while maneuvering
- Easily store them away when not in use, ensuring they're readily available whenever icy conditions demand that extra lubrication



**SKU:** 860202485

**MSRP:** 160 €

**Fits On:** Radien-X 600 mm (24")

**Installation time:** 10 min

**Margin :** 35 %

**Availability :** Available now

# Navigator Ski Protector



## Competitive Edge

Designed specifically for the Blade XC+ ski. Works in conjunction with any existing carbide runner.

Protects skis against wear at the front, extending their lifespan.

## Features & Descriptions

- Easily replaceable if worn out
- The plate's grooves reduce darting, allowing the runners to carve a fresh path, enhancing control and stability
- Compatible with any single runner made.
- Sold in pairs



**SKU:** 860202922

**MSRP:** \$59.99 US / \$79.99 CA / 69 €

**Fits On:** Blade XC+ Ski

**Installation time:** 15 min

**Margin :** 35%

**Availability :**

# Runner Carbide Updates - Improved durability

## Competitive Edge

Introducing enhanced Runner Carbide kit for the Blade and LTS Ski.

Our commitment to elevating the quality of these components ensures greater reliability in our products.

- **Improved durability** of the runners and **stabilized overall quality** have been achieved through the optimization of the heat treatment process in production.
- **Improved fit and finish** enhance the overall appearance, providing a polished and appealing outlook.

## SKU Changes

- Previously identified by SKU 860200959, has been upgraded to the superior new SKU 860202518 and 860202821.
- Previously identified by SKUs 605352643, 619400005, and 619400006, has been upgraded to the superior new SKU 860202822.

## Features & Descriptions

**SKU:** 860202518 **Fits On:** Blade XC, XC+, DS, DS+ 

**SKU:** 860202821 **Fits On:** Blade Ski

**SKU:** 860202822 **Fits On:** ADJ Ski

**MSRP:** 104 €\*

**Margin :** 35 %

**Availability :** Ready and accessible immediate

(\*€ inc. VAT)

# Air Radiator

## Competitive Edge

Offers additional cooling support, particularly effective in extreme conditions, ensuring your engine maintains optimal temperature levels.

## Features & Descriptions

- Designed for 600R and 850 E-TEC engines and Radien<sup>2</sup> platform
- Complete kit includes also brackets, installation hardware and harnesses
- Electric start is necessary during assembly for optimal functionality
- Standard on 49 Ranger Pro

Not illustrated

**SKU:** 860202796

**MSRP:** 599,00 €

**Fits On:** Radien<sup>2</sup> (except Deep Snow)

**Installation time:** 120 min

**Margin :** 35 %

**Availability :** August 2024



# QRS XD ROLLER SKI-DOO & LYNX

new



Kit of 2

SKU: 861805577 – Available April 2024

This **NEW & UNIQUE material combination** used in the QRS XD rollers, offers improved impact resistance. with no compromise in efficiency.

- **Higher resistance** to wear and deformation,
- Ensures **consistent roller diameter** for long-lasting performance,
- **Prevents premature wear** of critical **QRS clutch components** and drive belt.
- Fits all Snowmobile QRS secondary clutches – **2008 and up.**



**+62%** Impact Resistance

**+43%** Crush Resistance

 Top performer in aftermarket benchmark

# RAVE - CUSTOMIZE YOUR RIDE

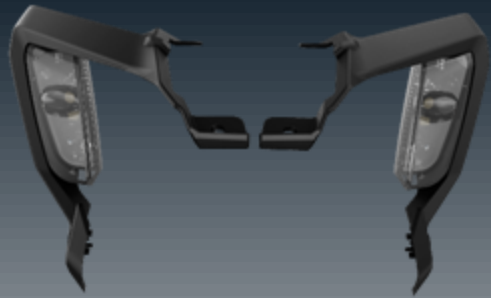

**NEW**  
**LYNX** AUXILIARY LED WIDE LIGHTS



**NEW**  
**LYNX** MAGNETIC SPARE LENS HOLDER

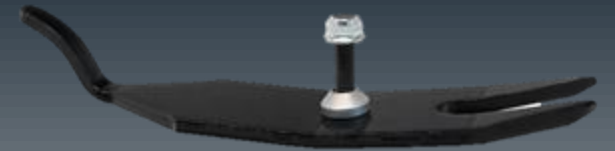

**NEW**  
**LYNX** NAVIGATOR SKI PROTECOTR



**COMMON** LINQ PRO BAG



**NEW**  
**COMMON** LINQ SADDLE BAGS 23 L

# XTERRAIN - CUSTOMIZE YOUR RIDE

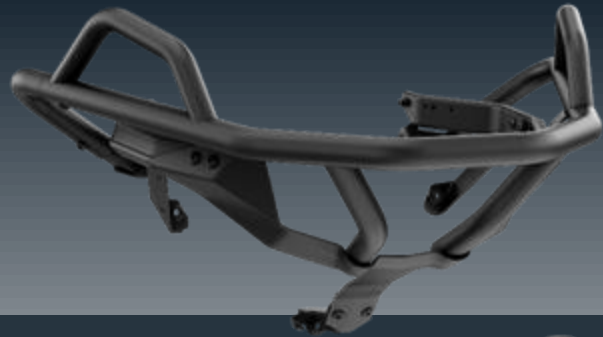

**NEW**  
**LYNX** HEAVY-DUTY BUMPER



**NEW**  
**COMMON** ADJUSTABLE WINDSHIELD MEDIUM-HIGH



**NEW**  
**COMMON** LED SIGNAL LIGHTS FOR WINDSHIELD



**NEW**  
**COMMON** LINQ SADDLE BAGS 23 L



**COMMON** REMOVABLE 1+1 RACK





# 49 RANGER - CUSTOMIZE YOUR RIDE

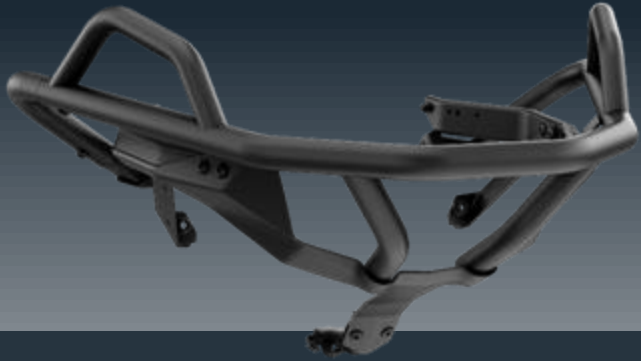

**NEW**  
**LYNX** HEAVY-DUTY BUMPER



**NEW**  
**LYNX** MAGNETIC SPARE LENS HOLDER

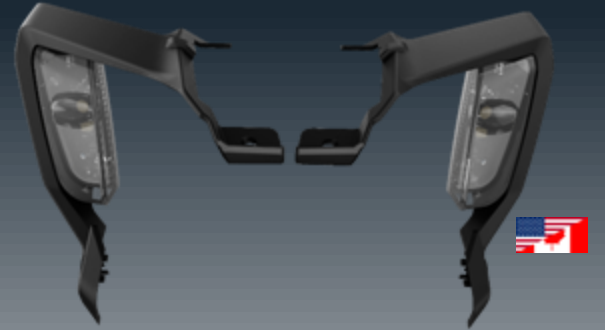

**NEW**  
**LYNX** AUXILIARY LED WIDE LIGHTS



**NEW**  
**LYNX** SUSPENSION PACKAGE FRONT



**NEW**  
**LYNX** SUSPENSION PACKAGE REAR

# COMMANDER - CUSTOMIZE YOUR RIDE



**NEW**  
**COMMON** VACUUM FLASK HOLDER



**NEW**  
**COMMON** UNDERSEAT STORAGE BAG - 11 L



**NEW**  
**LYNX** SUSPENSION PACKAGE FRONT



**NEW**  
**LYNX** SUSPENSION PACKAGE REAR





# SHREDDER - CUSTOMIZE YOUR RIDE



**NEW**  
**LYNX** SOFT GLOVE BOX EXTENSION



**NEW**  
**LYNX** DEEP SNOW ULTRA-LIGHT SEAT