

can-am®



MAVERICK

2025

Product Spec Book for Vehicle Specifications, Accessories and Parts & Maintenance

IF WE SELL IT, WE STAND BY IT.

BRP Limited Warranty*

for new Parts, Accessories
and Riding Gear

1-year limited warranty**

- Genuine BRP Parts and Accessories installed by you or your authorized BRP dealer
- Aftermarket Products sold through BRP
- Riding Gear

4-year limited warranty**

- Helmets

GET ALL THE DETAILS FROM YOUR CAN-AM OFF-ROAD DEALER

* Purchased at an authorized BRP dealership/distributor or on a BRP-authorized online store. Other exclusions may apply; see complete limited warranty or contact your Can-Am Off-Road authorized dealer. This limited warranty does not apply to factory-installed accessories and Evinrude parts and accessories.

** Unless otherwise stipulated or required by law.

CANAMOFFROAD.COM

© 2024 Bombardier Recreational Products Inc. (BRP). All rights reserved. ®, TM and the BRP logo are trademarks of BRP or its affiliates. In the USA, products are distributed by BRP US Inc. †All other trademarks are the property of their respective owners. BRP reserves the right to discontinue or change specifications, prices, designs, features, models or equipment without incurring obligation. Some models shown may include optional equipment. Product performance may vary depending on external factors. BRP recommends that all SxS drivers take a training course. See your dealer. SxS can be hazardous to operate. Never exceed the SxS's passenger capacity. All SxS models are meant to be used by drivers aged 16 and older. Read the operator's guide. Follow all instructional and safety material and observe applicable laws and regulations. SxS are for off-road use only; never ride on paved surfaces or public roads. For your safety, the operator and passenger(s) must wear a helmet, eye protection and applicable protective clothing. Always remember that riding and alcohol/drugs don't mix. Never engage in stunt driving. Avoid excessive speed and be particularly careful on difficult terrain. Always ride responsibly and safely. See your authorized BRP dealer for details and visit <https://can-am.brp.com/>.



CUSTOMIZING MADE EASY

1

Select the model.

2

Select the package.

3

Customize color, engine, and accessories (or accessory bundles) for your vehicle.

4

Click “Save” or “Send to dealer.”



If you can dream it, you can build it. And ride it. Creating a Can-Am vehicle tailor-made for our riders' needs has never been easier. Scan the QR code and follow the step-by-step above.

**BUILD
YOURS NOW**



TECHNICAL SPECIFICATIONS

MAVERICK



MAVERICK DS TURBO RR

Scandi Blue & Orange Crush



MAVERICK X RS TURBO RR

Triple Black



MAVERICK X RS TURBO RR SAS

Fiery Red & Hyper Silver



MAVERICK X RC TURBO RR

Hybrid White & Legion Red



MAVERICK MAX X RS TURBO RR SAS

Fiery Red & Hyper Silver

ENGINES		SUSPENSIONS		TIRES / WHEELS		BRAKES		DIMENSIONS / CAPACITIES		FEATURES	
Type	200 hp, Rotax ACE (Advanced Combustion Efficiency) 900 cc Turbocharged Triple-cylinder engine, liquid cooled with integrated intercooler and high-performance air filter	200 hp, Rotax ACE (Advanced Combustion Efficiency) 900 cc Turbocharged Triple-cylinder engine, liquid cooled with integrated intercooler and high-performance air filter	200 hp, Rotax ACE (Advanced Combustion Efficiency) 900 cc Turbocharged Triple-cylinder engine, liquid cooled with integrated intercooler and high-performance air filter	200 hp, Rotax ACE (Advanced Combustion Efficiency) 900 cc Turbocharged Triple-cylinder engine, liquid cooled with integrated intercooler and high-performance air filter	200 hp, Rotax ACE (Advanced Combustion Efficiency) 900 cc Turbocharged Triple-cylinder engine, liquid cooled with integrated intercooler and high-performance air filter						
Fuel Delivery System	Intelligent Throttle Control (iTC™) with Electronic Fuel Injection (EFI)	Intelligent Throttle Control (iTC™) with Electronic Fuel Injection (EFI)	Intelligent Throttle Control (iTC™) with Electronic Fuel Injection (EFI)	Intelligent Throttle Control (iTC™) with Electronic Fuel Injection (EFI)	Intelligent Throttle Control (iTC™) with Electronic Fuel Injection (EFI)						
Transmission	pDrive primary and Quick Response System X (QRS-X) CVT with high airflow L / H / N / R / P	pDrive primary and Quick Response System X (QRS-X) CVT with high airflow L / H / N / R / P	pDrive primary and Quick Response System X (QRS-X) CVT with high airflow L / H / N / R / P	pDrive primary and Quick Response System X (QRS-X) CVT with high airflow L / H / N / R / P	pDrive primary and Quick Response System X (QRS-X) CVT with high airflow L / H / N / R / P						
Drive Train	Lockable front differential with exclusive Smart-Lok™ True 2WD / 4WD with front diff. lock / 4WD TRAIL ACTIV / 4WD TRAIL	Lockable front differential with exclusive Smart-Lok™ True 2WD / 4WD with front diff. lock / 4WD TRAIL ACTIV / 4WD TRAIL	Lockable front differential with exclusive Smart-Lok™ True 2WD / 4WD with front diff. lock / 4WD TRAIL ACTIV / 4WD TRAIL	Lockable front differential with exclusive Smart-Lok™ True 2WD / 4WD with front diff. lock / 4WD TRAIL ACTIV / 4WD TRAIL	Lockable front differential with exclusive Smart-Lok™ True 2WD / 4WD with front diff. lock / 4WD TRAIL ACTIV / 4WD TRAIL						
Power Steering	High torque Tri-Mode Dynamic Power Steering (DPS™)	High torque Tri-Mode Dynamic Power Steering (DPS™)	High torque Tri-Mode Dynamic Power Steering (DPS™)	High torque Tri-Mode Dynamic Power Steering (DPS™)	High torque Tri-Mode Dynamic Power Steering (DPS™)						
Front Suspension	Double A-arm with sway bar / 20 in. (50.8 cm) suspension travel	Double A-arm with sway bar / 22 in. (55.9 cm) suspension travel / Trophy truck inspired arms	Double A-arm with sway bar / 22 in. (55.9 cm) suspension travel / Trophy truck inspired arms	Trophy truck inspired double arched A-arm with sway bar / 22 in. (55.9 cm) suspension travel	Double A-arm with sway bar / 22 in. (55.9 cm) suspension travel / Trophy truck inspired arms						
Front Shocks	SHOWA HPG piggyback 2.5 (Dual Speed Compression, Dual-rate spring)	FOX† 2.5 PODIUM RC2† Piggyback with bypass, dual speed compression and rebound adjustments	FOX† 2.5 PODIUM† Piggyback with bypass and Smart-Shox** Technology featuring DDA Valve (Dynamic Damping Adjustment)	FOX† 2.5 PODIUM RC2† Piggyback with bypass, dual speed compression and rebound adjustments	FOX† 2.5 PODIUM† Piggyback with bypass and Smart-Shox** Technology featuring DDA Valve (Dynamic Damping Adjustment)						
Rear Suspension	4-link Torsional Trailing-arm X (TTX) with sway bar / 20 in. (50.8 cm) suspension travel	4-link Torsional Trailing-arm X (TTX) with sway bar / 24 in. (61 cm) suspension travel	4-link Torsional Trailing-arm X (TTX) with sway bar / 24 in. (61 cm) suspension travel	4-link Torsional Trailing-arm X (TTX) with sway bar and arched lower links / 24 in. (61 cm) suspension travel	4-link Torsional Trailing-arm X (TTX) with sway bar / 22 in. (55.9 cm) suspension travel						
Rear Shocks	SHOWA HPG piggyback 2.5 (Dual Speed Compression, Dual-rate spring)	FOX† 3.0 PODIUM RC2† with bypass, dual speed compression and rebound adjustments	FOX† 3.0 PODIUM† with bypass and Smart-Shox** Technology featuring DDA Valve (Dynamic Damping Adjustment) **Smart-Shox was developed in conjunction with Tractive Industries, a market leader in the suspension industry	FOX† 3.0 PODIUM RC2† with bypass, dual speed compression and rebound adjustments	FOX† 3.0 PODIUM† with bypass and Smart-Shox** Technology featuring DDA Valve (Dynamic Damping Adjustment) **Smart-Shox was developed in conjunction with Tractive Industries, a market leader in the suspension industry						
Front / Rear Tires	Maxxis Carnivore† 30 x 10 x 14 in.	XPS Trac Force 32 x 10 x 15 in.	XPS Trac Force 32 x 10 x 15 in.	Maxxis Liberty† 32 x 10 x 15 in.	XPS Trac Force 32 x 10 x 15 in.						
Wheels	14 in. cast-aluminum	15 in. cast-aluminum beadlock	15 in. cast-aluminum beadlock	15 in. cast-aluminum beadlock	15 in. cast-aluminum beadlock						
Front	Dual 262 mm disc brakes with hydraulic twin-piston calipers	Dual 262 mm disc brakes with hydraulic twin-piston calipers	Dual 262 mm disc brakes with hydraulic twin-piston calipers	Dual 262 mm disc brakes with hydraulic twin-piston calipers	Dual 262 mm disc brakes with hydraulic twin-piston calipers						
Rear	Dual 248 mm disc brakes with hydraulic twin-piston calipers	Dual 248 mm disc brakes with hydraulic twin-piston calipers	Dual 248 mm disc brakes with hydraulic twin-piston calipers	Dual 248 mm disc brakes with hydraulic twin-piston calipers	Dual 248 mm disc brakes with hydraulic twin-piston calipers						
Cage	Dual-phase 980 steel	Dual-phase 980 steel	Dual-phase 980 steel	Dual-phase 980 steel	Dual-phase 980 steel						
Estimated Dry Weight*	1,546 lb (701.3 kg)	1,680 lb (762 kg)	1,699 lb (770.7 kg)	1,843 lb (836 kg)	1,942 lb (880.9 kg)						
L x W x H	132 x 64 x 65.4 in. (335.3 x 162.5 x 166.1 cm)	132 x 72.7 x 68.5 in. (335.3 x 184.7 x 174 cm)	132 x 72.7 x 68.5 in. (335.3 x 184.7 x 174 cm)	134.5 x 72.8 x 68.5 in. (341.6 x 184.9 x 174 cm)	165 x 72.7 x 68.5 in. (419.1 x 184.7 x 174 cm)						
Wheelbase	102 in. (259.1 cm)	102 in. (259.1 cm)	102 in. (259.1 cm)	102 in. (259.1 cm)	135 in. (342.9 cm)						
Ground Clearance	14 in. (35.6 cm)	16 in. (40.6 cm)	16 in. (40.6 cm)	16 in. (40.6 cm)	16 in. (40.6 cm)						
Cargo Box Capacity	200 lb (91 kg) with LinQ™ quick-attach	200 lb (91 kg) with LinQ™ quick-attach	200 lb (91 kg) with LinQ™ quick-attach	200 lb (91 kg) with LinQ™ quick-attach	150 lb (68 kg) with LinQ™ quick-attach						
Storage Capacity	Total: 2.5 gal (9.4 L)	Total: 2.5 gal (9.4 L)	Total: 2.5 gal (9.4 L)	Total: 2.5 gal (9.4 L)	Total: 3 gal (11.4 L)						
Person Capacity	10.5 gal (40 L)	10.5 gal (40 L)	10.5 gal (40 L)	10.5 gal (40 L)	10.5 gal (40 L)						
Gauge	4.5 in. wide digital display with keypad	7.6 in. wide digital display with keypad	7.6 in. wide digital display with keypad	7.6 in. wide digital display with keypad	7.6 in. wide digital display with keypad						
Magneto	850-W	850-W	850-W	850-W	850-W						
Instrumentation	DC outlet (10-A)	DC outlet (10-A)	DC outlet (10-A)	DC outlet (10-A)	DC outlet (10-A)						
Lighting	LED Headlight LED tail lights	LED Headlight LED Signature LED tail lights	LED Headlight LED Signature LED tail lights	LED Headlight LED Signature LED tail lights	LED Headlight LED Signature LED tail lights						
Winch	N/A	N/A	N/A	4,500 lb (2,041 kg) winch with synthetic rope	N/A						
Protection	Integrated front bumper Quarter-doors HMWPE full skid plate Rear tow hook	Integrated front bumper Quarter-doors Full hard roof 4-point harness with shoulder pads HMWPE full skid plate Rear tow hook	Integrated front bumper Quarter-doors Full hard roof 4-point harness with shoulder pads HMWPE full skid plate Rear tow hook	Front bumper Half-doors Aluminum roof Intrusion bar 4-point harness with shoulder pads UHMWPE rock sliders HMWPE skid plates: Full heavy duty with differential / Under bumper / Front and rear suspension arm Rear tow hook Trailing Arm protector	Integrated front bumper Quarter-doors Full hard roof 4-point harness with shoulder pads HMWPE full skid plate Rear tow hook						

MAVERICK ACCESSORIES

Roofs	9
Soft Cab Enclosure	10
Windshields & Wind Protection	10
Mirrors	12
Doors	13
Seat Accessories	14
HMWPE Skid Plates	15
Bumpers & Guards	16
LinQ: Easy On, Easy Off Cargo	19
Racks & Storage	23
Lights	25
Audio & Communication Systems	29
Electrical & Electronic Accessories	30
Winches & Hitches	32
Performance	34
Apache Track Systems	37
ProMount Plows	39
Cover & Trailering	42

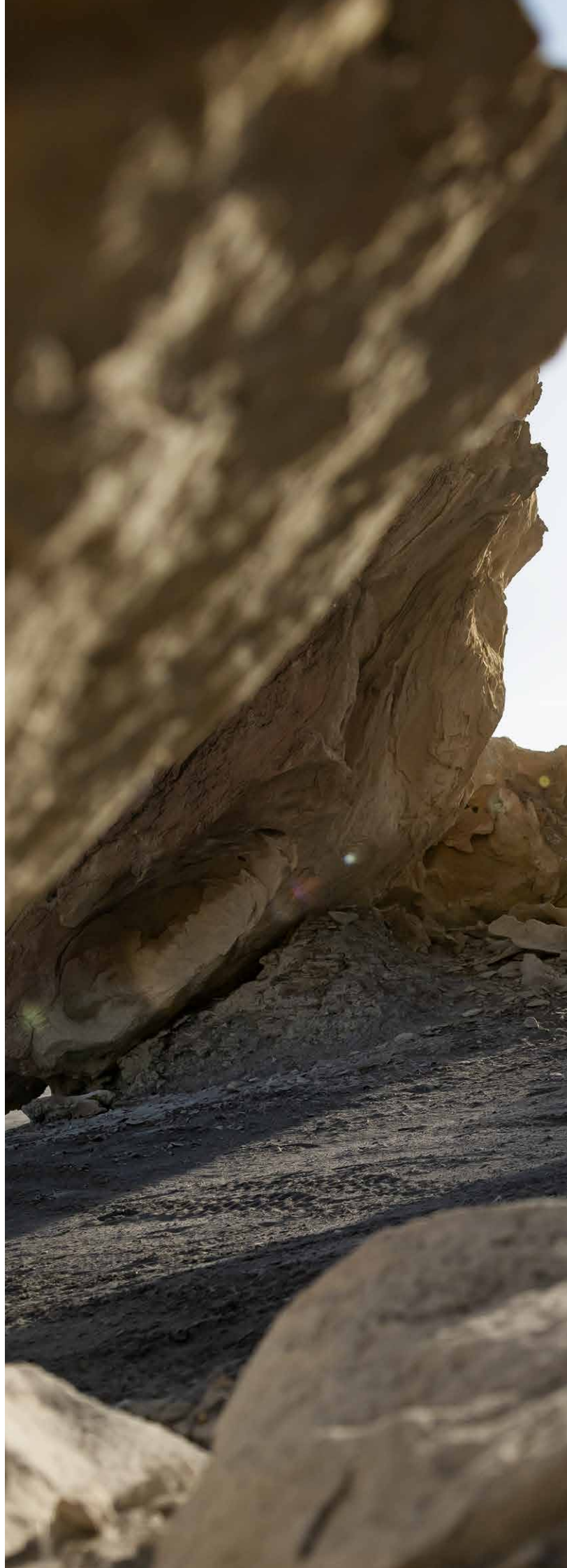



BUNDLE UP TO GET AFTER IT. YOUR MAVERICK BUNDLES.

STEP 1: CHOOSE YOUR ESSENTIAL BUNDLE

		Maverick	Maverick MAX
STARTER	Sport Roof	715005521	715003750
	Tinted Half Windshield	715004291	715004291
	Rear Wind Screen	715006701	715006701
	Rally Side Mirrors	715005262	715005262
	Front Lower Door Panels	715002903	715002903
	Rear Lower Door Panels	N/A	715003751
ADVANCED	Electronic Device Holder	715002874	715002874
	Shoulder Storage Bag	715004277	715004277
	LinQ 8 Gal (30L) Cooler Box	715004778	715004778
PEAK	Rear View Mirror and Camera Monitor	715009410	715009410
	Front Pre-Runner Bumper	715002878	715002878
	Fender Flares	715002973	715002973
	LinQ Tool Kit	715006829	715006829
	Adventure Roof Rack	715006225	715003868

STEP 2: PICK YOUR ADD-ON BUNDLE

		Maverick	Maverick MAX
AUDIO	Can-Am Audio Roof	715007130	715006709
	Can-Am Audio Roof Flip Kit	715007131	715007131
	Can-Am Subwoofer	715004956	715004956
	Can-Am Amplifier Kit	715007227	715007227
LIGHT	Light Support Bar	715003529	715003529
	Light Power Cable	715007117	715007117
	40" Baja Designs OnX6 Arc LED Light Bar	710006818	710006818
	Chase Lights	715009887	715009887
RIDER	4-Point Harness (Driver)	715005021	715005021
	4-Point Harness (Passenger)	715005022	715005022
	Lonestar Racing Fire Extinguisher Support	715007320	715007320
CABIN STORAGE	Overhead Storage Bag	715004275	715004275
	Upper Door Storage Bags	715004276	715004276
	Lower Door Panel Storage Bags	715004355	715004355
	Front Storage Bag	N/A	715004888

ROOFS

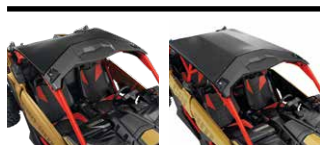
Sport Roof	Maverick Maverick MAX	715005521 715003750
	<ul style="list-style-type: none"> • Impact-resistant injected polypropylene. • Excellent protection from the elements. • Provides excellent downhill visibility. • Windshield compatible. • Standard on X rs model. • Easy, tool-less installation and removal with quick-release ¼ turn fasteners and Velcro straps. 	
ProVent Roof Module Kit	Maverick, Maverick MAX	715005279
	<ul style="list-style-type: none"> • Provides fresh air in the cab area. • Optimal performance with full cab enclosure. • 4 vents provide infinite adjustment of air flow for driver and passenger. • Filter and pre-filter to limit dust intrusion. • Easy cleaning of filter and pre-filter. • Patent pending water management system to keep water out of cabin while maintaining air flow. • Outer plug closes air intake completely for winter or heavy weather. • Sport Roof requires ProVent Module Adapter Kit. • Not compatible with roof mounted LED bars, roof racks (715006225/715003868) or roof liners, Lonestar Roof, or Bimini tops. 	
ProVent Roof Module Adapter Kit for Sport Roof <i>(Not illustrated)</i>	Maverick Maverick MAX	715006199 715006371
<ul style="list-style-type: none"> • Adapter for fitting ProVent Roof Module Kit onto Maverick X3. • Includes roof adapter and hardware. • Requires ProVent Roof Module Kit (715005279). 		
Aluminum Roof	Maverick	<ul style="list-style-type: none"> ■ 715004224 · Black ■ 715002900 · Silver
	<ul style="list-style-type: none"> • Formed aluminum roof 0.09" (2.3 mm) thick. • Durable and lightweight. • Sporty look. • Windshield compatible. • Easy and tool-less installation. 	
Bimini[†] Roof with Sun Visor	Maverick Maverick MAX	715002901 715003749
	<ul style="list-style-type: none"> • Heavy-duty canvas made of UV-resistant solution-dyed polyester. • Innovative soft top comes with a hard visor that allows for storage of rolled-up soft top. • Easy, tool-less installation and removal with quick-release/turn fasteners and Velcro straps. 	
Tinted Sun Visor	Maverick, Maverick MAX	715007098
	<ul style="list-style-type: none"> • Tinted polycarbonate construction. • Extra protection for driver and passenger from the sun. • Not compatible with Aluminum Roof, Audio Roof or Full Windshields. 	
Lonestar Racing Aluminum Roof	Maverick produced after January 1, 2017 Maverick MAX	<ul style="list-style-type: none"> ■ 715005507 · Black ■ 715005515 · Black
	<ul style="list-style-type: none"> • 0.083" (2.1 mm) thick aluminum roof. • Durable and lightweight. • Enhances the vehicle's racing appearance thanks to an authentic sporty look combined with unique graphics. • Offers you protection from the elements with a personalized touch. • Lower profile than other roofs. • Compatible with Lonestar Racing Light Bar Racks. • Not compatible with LinQ Pivoting Rack, Light Support Bar and Full Windshields. • "Lonestar Racing for Can-Am" branded. • Includes middle intrusion bars for installation. 	

SOFT CAB ENCLOSURE

Soft Cab Enclosure	Maverick (except X mr models)	715003754
	Maverick MAX (except X mr models)	715003755



- Protection for rider and passenger from the elements.
- For added cabin comfort, complete your cab enclosure with Cab Seal Kit.

- Includes:
 - Bimini roof with sun visor
 - Full windshield — hardcoated
 - Upper soft door panels
 - Front lower door panels
 - Soft rear window

Cab Seal Kit <i>(Not illustrated)</i>	Maverick	715004433
	Maverick MAX	715004434

- Prevents dirt, dust and wind infiltration in the cab area.
- Improves cabin comfort for driver and passenger.
- Recommended with Soft Cab Enclosures.

WINDSHIELDS & WIND PROTECTION

Windshields

PowerFlip Windshield	Maverick, Maverick MAX	715007097
-----------------------------	------------------------	------------------



- The PowerFlip Windshield is equipped with electric cylinders that allow the rider to adjust the windshield opening at the touch of a button.
- Windshield is made of hardcoated polycarbonate with a rubber seal contour and a tinted top section.
- Allows you to quickly adapt to changing conditions by adjusting the windshield as you go.

- Can be fully opened for optimal visibility and ventilation, fully closed for maximum protection from the elements, and in between, you have an infinite number of opening possibilities depending on protection, visibility and air flow preferences.
- Compatible with Can-Am roofs.

Windshield Wiper for PowerFlip Windshield	Maverick, Maverick MAX	715006310
--	------------------------	------------------



- An ideal way to keep your windshield clear in rain or while riding through mud and water.
- Wiper from the top allows windshield pivoting. Includes single-speed wiper and washer-fluid dispenser.

- Wiper mechanism and washer-fluid dispenser perfectly concealed within the vehicle.
- Must be installed with the PowerFlip Windshield (sold separately).

Provent Windshield	Maverick, Maverick MAX	715005277
---------------------------	------------------------	------------------



- High-impact-resistant Quantum hardcoated polycarbonate full windshield.
- Controllable vents to manage air flow.
- Optimal performance with full cab enclosure.
- Channels air into the cabin, defogs windshield, fully closes to eliminate air flow.
- One upper vent and one lower vent with pre-filters.
- Formed polycarbonate construction for enhanced rigidity.

- Protects driver and passenger from the elements.
- Quick and easy tool-less installation or removal.
- Not compatible with wiper kits and Wet Sounds Stealth 6 Ultra HD Can-Am Edition Sound Bar.
- Upper vent channels air into the cabin.
- Lower vents defog windshield.
- Provides excellent optical clarity and better abrasion resistance.

Glass Windshield	Maverick, Maverick MAX	715008859
-------------------------	------------------------	------------------



- Curved and laminated glass full windshield.
- Seals firmly against the cage and protects rider and passenger from the elements.
- Provides the best optical clarity and abrasion resistance.
- Must be used with Windshield Wiper & Washer Kit to maintain clear visibility during severe riding conditions, such as mud riding.
- Recommended to use with rear wind protection to maximize comfort for passenger.

Glass Windshield with Wiper & Washer Kit

Maverick, Maverick MAX

715008858

- Complete kit that includes a curved and laminated glass windshield with a single-speed wiper and washer fluid dispenser.
- Seals firmly against the cage and protects rider and passenger from the elements.
- An ideal way to keep your windshield clear in rain, or while riding through mud and water.
- Recommended to use with rear wind protection to maximize comfort for passenger.

Full Windshield

Maverick, Maverick MAX

715002907

- High-impact-resistant durable polycarbonate full windshield.
- Formed polycarbonate construction for enhanced rigidity.
- Formulated to be non-yellowing, non-crazing, non-cracking with excellent UV resistance and optical clarity.
- Protects driver and passenger from the elements.
- Quick and easy tool-less installation or removal.
- Recommended to use with rear wind protection to maximize comfort for passenger.

Full Windshield – Hardcoated

Maverick, Maverick MAX

715004417

- High-impact-resistant Quantum hardcoated polycarbonate full windshield.
- Formed polycarbonate construction for enhanced rigidity.
- Provides excellent optical clarity and better abrasion resistance.
- Protects driver and passenger from the elements.
- Quick and easy tool-less installation or removal.
- Recommended to use with rear wind protection to maximize comfort for passenger.
- Can be used with the Windshield Wiper and Washer Kit (715004762).

Half Windshield

Maverick, Maverick MAX

 715002909 · Clear
 715004291 · Tinted

- High-impact-resistant durable polycarbonate half windshield.
- Formed polycarbonate construction for enhanced rigidity.
- Formulated to be non-yellowing, non-crazing, non-cracking with excellent UV resistance and optical clarity.
- Protects driver and passenger from the elements.
- Features reverse angle lip to deflect air flow.
- Quick and easy tool-less installation or removal.

Windshield Wiper & Washer Kit

Maverick, Maverick MAX Fit with Full Windshield Hardcoated (715004417)

715004762

Maverick, Maverick MAX Fit with Glass Windshield (715008859)

715003282

- An ideal way to keep your windshield clear in rain, or while riding through mud and water.
- Includes single-speed wiper and washer fluid dispenser.
- Wiper mechanism and washer fluid dispenser perfectly concealed within the vehicle.

Manual Wiper Kit

Maverick, Maverick MAX

715009424

- Single manual wiper that can be used to clear windshield of debris.
- Easy to install system that requires no electrical hookup.
- Large ergonomic handle provides a good grip over the entire sweeping surface.
- Compatible with glass and hardcoated windshields that use top mounted wipers.

Wind Protection

Rear Wind Screen

Maverick, Maverick MAX
(except X mr models)

715006701



- Full rear mesh screen reduces windshield backdraft for added cabin comfort.
- Installs quickly and easily on roll cage.
- Large white Can-Am logo on black mesh.

Rear Polycarbonate Window

Maverick, Maverick MAX
(except X mr models)

715006387



- High-impact-resistant polycarbonate window.
- Blocks windshield backdraft or dust and rain from entering for added cabin comfort.
- Quick and easy tool-less installation.
- Ready for MTX Audio System Rear Speakers.

Soft Rear Window

Maverick, Maverick MAX
(except X mr models)

715006702



- Clear, flexible window made from transparent vinyl.
- Resists cold-cracking to -4°F (-20°C).
- Ideal for preventing backdraft of dust or rain in harsh environments.
- Quick tool-less installation.

MIRRORS

Aluminum Side Mirrors

Maverick, Maverick MAX

715007363



- Sleek design.
- High-quality black molded aluminum for extreme durability.
- The convex surface provides a wider field of view and better visibility around the unit.
- Can be installed at any height on the cage A-pillar for optimized rider vision.
- Possibility to install the Integrated LED Side Mirror Lights (715007185).
- Adjustable ball-joint mirrors.
- Possibility to fold down the mirrors (fold-away mechanism).
- Not compatible with Glass Windshield.
- Sold in pairs.

Side Mirrors

Maverick, Maverick MAX

715007188



- Sleek design.
- High-impact resistant plastic mirrors.
- The convex surface provides a wider field of view and better visibility around the unit.
- Can be installed at any height on the cage A-pillar for optimized rider vision.
- Adjustable ball-joint mirrors.
- Possibility to fold down the mirrors (fold-away mechanism).
- Not compatible with Glass Windshield.
- Sold in pairs.

Side Mirrors

Maverick, Maverick MAX

715004236

• For stock quarter doors

715005315

• For aluminum doors



- Rugged cast aluminum mount with black nylon cover.
- Multi-position adjustable ball-joint mounted mirrors.
- Convex optics for a wide viewing angle.
- Spring-loaded pivots let mirrors fold back completely.
- Door mounted.
- Compatible with Upper Soft Door Panels.
- Sold in pairs.

Racing Side Mirrors

Maverick, Maverick MAX

715002898



- Race-inspired design features rugged black nylon 90% construction with coated cast-aluminum mount.
- Dual adjustment provides optimal field of view (FOV).
- Multi-position adjustable ball-joint mounted mirrors.
- Flat optics deliver improved distance perception.
- Spring-loaded pivots let mirrors fold back completely.
- Not compatible with Lonestar Racing Light Racks, Upper Soft Door Panels or Flip Audio Roof Kit (715007131).
- Sold in pairs.

Rally Side Mirrors

Maverick, Maverick MAX

715005262



- Sleek design with unique racing style.
- High-quality black molded aluminum for extreme durability.
- 4" (10 cm) convex surface provides a wider field of view and better visibility around the unit.
- Can be installed at any height on the cage A-pillar for optimized rider vision.
- Multi-position adjustable ball-joint-mounted mirrors.
- Spring-loaded pivots let mirrors fold back completely.
- Sold in pairs.
- Not compatible with Glass Windshield.

Rear Mirror & Camera Monitor

Maverick, Maverick MAX

715009410



- Fully waterproof rearview mirror and monitor kit.
- See exactly what you need to see with the multiple camera feeds from the rear view camera.
- This unit replaces the stock rearview mirror (the screen is integrated in the unit's replacement rearview mirror).
- The camera uses infrared light for night vision capabilities.

DOORS

Aluminum Half Doors

Maverick, Maverick MAX

715007971 · Front

Maverick MAX

715007972 · Rear



- Lightweight half doors made of formed $\frac{5}{64}$ " (2 mm) thick aluminum.
- Smooth finish.
- Engineered for maximum rigidity and durability.
- Designed for a perfect fit and seamless integration with the vehicle's lines.
- Contoured with a thick seal for better protection from the elements.
- Easy installation using the standard door frame.
- Includes the easy-to-operate Deluxe Door Handles.
- Compatible with the Upper Soft Door Panels, the Window Nets and Upper Door Storage Bags.
- Not compatible with the Lower Door Panel Storage Bags.
- Sold in pairs.

Deluxe Door Handles

Maverick, Maverick MAX

715004758 · Front

Maverick MAX

715004860 · Rear

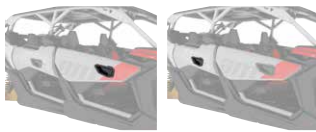

- Convert the standard door straps into easy-to-access door handles.
- Include inside and outside handles for each door.
- Greatly facilitate door opening.
- Standard on accessory Aluminum Half Doors.
- Sold in pairs.

Lower Door Panels

Maverick, Maverick MAX

715002903 · Front

715003751 · Rear



- Robust injection-molded polypropylene construction designed to match vehicle.
- Extend stock doors at bottom to protect from the elements.
- A great-looking add-on.
- Easy and quick installation.
- Sold in pairs.

	Maverick	715006693 · Front
	Maverick MAX	715004694 · Front
	Maverick MAX	715006700 · Rear

Window Nets



- Window mesh screen for added protection from wind.
- Can be easily lowered in seconds.
- Sold in pairs.
- Not compatible with Can-Am Audio Roof.

	Maverick (except X mr models)	715008091 · 2 doors
	Maverick MAX (except X mr models)	715008092 · 4 doors

Upper Soft Door Panels



- Weather-resistant panels reinforced with aluminum frame offer good protection from the elements.
- Extend stock quarter doors at the top.
- Made of heavy-duty UV-resistant solution-dyed polyester canvas for excellent resistance to tear and abrasion.
- Zip-down windows made of laminated polished vinyl material for added ventilation.
- To be combined with the Lower Door Panels to obtain complete door kits for your vehicle.
- Not compatible with Racing Side Mirrors and Can-Am Audio Roof.

SEAT ACCESSORIES

	Maverick, Maverick MAX	715008033 · Driver 715008034 · Passenger
--	------------------------	---

4-Point Harness



- Exclusive controlled decelerator technology (patent pending) absorbs additional energy in case of accident.
- Designed to offer maximum riding comfort.
- Easy one-click latch and release.
- Patent pending.
- Not EC compliant.

	Maverick, Maverick MAX	715005021 · Driver 715005022 · Passenger
--	------------------------	---

Retractable 4-Point Harness



- Convenient harness allows you to move freely in your seat, and at the same time fully benefit from the extra support given by the 4-point attachments.
- Makes it easier to buckle up and requires fewer adjustments when switching passenger or driver.
- Retractor Protector (707900653) is required for installation on front seats of MAX models.
- Compatible with rear passenger seats on MAX models.
- Standard on select Maverick models.

	Maverick MAX	707900653
--	--------------	------------------

Retractor Protector

(Not illustrated)

- Protective pad required for the installation of the Retractable 4-Point Harness on front seat of MAX models.
- Protects the passengers from the retractor mechanism.
- Sold individually.

	Maverick, Maverick MAX	715002894
--	------------------------	------------------

Seat Belt Shoulder Pads



- Provide additional riding comfort by preventing seat belt from rubbing on neck and shoulder.
- Fit with stock 3-point seat belts and 4 point harness.
- Easy Velcro installation.
- Can-Am branded.
- Sold in pairs for driver and passenger.

HMWPE SKID PLATES

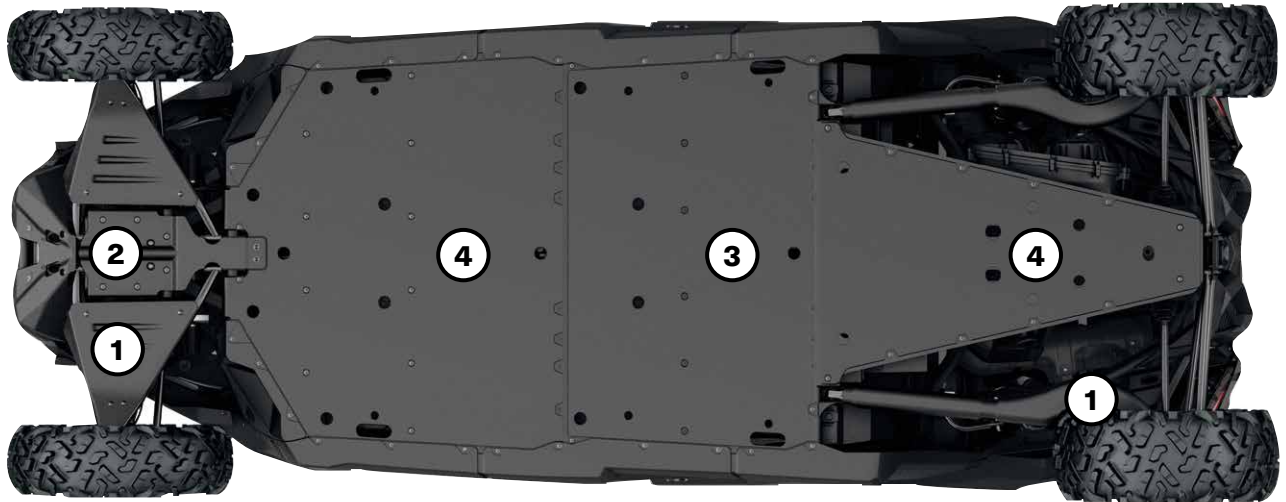

Our plastic plates glide smoothly and silently over obstacles, offering great protection in rough terrain. Made of abrasion-resistant thermoformed $\frac{3}{8}$ " (10 mm) thick High Molecular Weight Polyethylene (HMWPE).

- Lighter than aluminum.
- Superior stress crack resistance.
- High-impact strength.

MAVERICK, MAVERICK MAX

HMWPE Skid Plates are standard on X rs models (2019 to 2021) and X rc models (2022 & up) only.	Maverick 64" models	Maverick Max 64" models	Maverick, Maverick Max 72" models (except Base models)	Maverick Base 72" models	Maverick Max Base 72" models
HMWPE Skid Plate Protection Kit					
	715003713	715003747	715003718	715006767	715006769
Individual HMWPE Skid Plates					
① HMWPE Front A-Arm and Trailing Arm Protectors	715002905	715002905	715003552	715003552	715003552
② HMWPE Front Skid Plate	715003933	715003933	715003933	715003933	715003933
③ HMWPE Central Skid Plate	—	715003731	Standard on X rc models only	—	715003731
④ HMWPE Underbelly Plate	715004904	715004904	Standard on X rc models only	715004904	715004904

BUMPERS & GUARDS

Bumpers

Front Pre-Runner Bumper

Maverick, Maverick MAX

■ **715002878** · Black
■ **715003433** · Can-Am Red



- Made of 1.5" (3.8 cm) diameter steel tubing with a 1/8" (3 mm) aluminum plate for extra durability.
- Inside and outside anti-corrosion coating with durable powder coat finish.
- Added heavy-duty protection in extreme driving conditions.
- Integrated winch mounting plate and mount points for lights.

Rear Pre-Runner Bumper

Maverick, Maverick MAX

■ **715002880** · Black
■ **715003436** · Can-Am Red



- Extra-durable 1.5" (3.8 cm) diameter steel tubing with a 1/8" (3 mm) aluminum plate.
- Inside and outside anti-corrosion coating with durable powder coat finish.
- Protects vehicle bodywork and exhaust system.
- Rear Receiver Hitch compatible.
- Required for installation of the Rear Cage Extension.

Dune Front Bumper

Maverick, Maverick MAX

■ **715002961** · Black
■ **715003432** · Can-Am Red



- Made of 1.5" (3.8 cm) diameter aluminum tubing with a 1/8" (3 mm) aluminum plate.
- Inside and outside anti-corrosion coating with durable powder coat finish.
- Provides added protection without sacrificing the agility and performance advantages of a lighter weight design.
- Features a more pronounced attack angle and integrated mounting points for lights.
- Not winch compatible.

Dune Rear Bumper

Maverick, Maverick MAX 2021 & prior
Maverick, Maverick MAX 2022 & up

■ **715002962** · Black
■ **715003437** · Can-Am Red
■ **715009242** · Black



- Made of 1.5" (3.8 cm) diameter aluminum tubing with a 1/8" (3 mm) aluminum plate.
- Inside and outside anti-corrosion coating with durable powder coat finish.
- Provides added protection without sacrificing the agility and performance advantages of a lighter weight design.
- Protects vehicle bodywork and exhaust system.
- Rear hitch compatible.
- Not compatible with Rear Cage Extension and Lonestar Racing Spare Tire Holder.

X rc/X mr Front Bumper

Maverick, Maverick MAX

■ **715004788** · Black



- Made of 1.5" (3.8 cm) diameter steel tubing with a 1/8" (3 mm) aluminum plate.
- Inside and outside anti-corrosion coating with durable powder coat finish on steel tubing.
- Offers all the essential features required for technical driving: low front-end protection, support base for winch installation and integrated tow hook.
- Standard on Maverick X rc and X mr models.
- Not compatible with winches with steel cable.

Lonestar Racing Front Bumper

Maverick, Maverick MAX
(not compatible X mr and X rc models)

■ **715005510** · Hyper Silver
■ **715005509** · Black



- Made of 1.5" (3.8 cm) diameter steel tubing with durable powder coat finish and a 1/8" (3 mm) thick aluminum plate for added vehicle-front protection in extreme driving conditions.
- Sleek styling enhances the vehicle's race-inspired look.
- Not winch compatible.
- Not compatible with 10" (25 cm) Baja Designs OnX6 LED Light Bar.
- Not compatible with stock Smart-Shox.

Lonestar Racing Rear Bumper

Maverick, Maverick MAX 2021 & prior

- **715005512** · Hyper Silver
- **715005511** · Black
- **715004162** · Can-Am Red



- Made of 1.5" (3.8 cm) diameter steel tubing with durable powder coat finish.
- Provides additional vehicle-rear bodywork and exhaust system protection in extreme driving conditions.
- Sleek styling enhances the vehicle's race-inspired look.
- Compatible with Lonestar Racing Spare Tire Holder.
- Not hitch compatible.

S3⁺ Front Bumper

Maverick, Maverick MAX

- **715004867** · Black



- Made of 1.5" (3.8 cm) diameter steel tubing with a 1/8" (3 mm) aluminum plate for extra durability.
- Inside and outside anti-corrosion coating with durable powder coat finish.
- Added heavy-duty protection in extreme driving conditions.
- Integrated winch support plate and mount points for lights.
- Hook support anchor allows you to keep the winch hook within easy reach when riding in deep mud.
- "S3 for Can-Am" branded.
- Winch not included.

S3 Rear Bumper

Maverick, Maverick MAX 2021 & prior

- **715004869** · Black



- Made of extra-durable 1.5" (3.8 cm) diameter steel tubing.
- Inside and outside anti-corrosion coating with durable powder coat finish.
- Added heavy-duty protection in extreme driving conditions—protects vehicle bodywork and exhaust system.
- Permits installation of a winch at a higher location to improve accessibility in muddy conditions.
- "S3 for Can-Am" branded.
- Engineered to sustain heavy winch loads without damaging the vehicle's frame.
- Compatible with Can-Am HD and WARN VRX winches—Rear Winch Harness (715006007) is required to install a winch on the bumper.
- Includes a robust recovery hook to facilitate vehicle recovery.
- Winch not included.
- Not EC compliant.

Rock Sliders

Rock Sliders

Maverick (except X rc)

- **715002963** · Black
- **715003438** · Can-Am Red
- **715003730** · Black
- **715003888** · Can-Am Red



- Made of heavy-duty 1.5" (3.8 cm) diameter steel tubing.
- Inside and outside anti-corrosion coating with durable powder coat finish.
- Protect vehicle's sides and undercarriage against large obstacles.
- Support plate adds rigidity and style.
- Sold in pairs.

X rc UHMWPE Rock Sliders

Maverick

- **715004730**

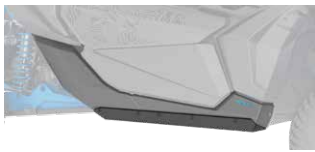

- Robust 1/4" (6 mm) UHMWPE construction.
- Include lower body panels and brackets for installation.
- Protect vehicle's sides and undercarriage against large obstacles.
- Lodge tight up against vehicle body for better clearance from obstacles.
- Slide smoothly over obstacles.
- Sold in pairs.

Lonestar Racing Rock Sliders

Maverick (except X rc models)

- **715005514** · Hyper Silver
- **715008845** · Black
- **715008846** · Can-Am Red
- **715008847** · Black
- **715008848** · Can-Am Red



- Race-engineered to Lonestar Racing's trademark standards for toughness, these stylishly crafted accessories will also enhance your vehicle with visual impact.
- Made of 1.5" (3.8 cm) diameter steel tubing with durable powder coat finish.
- Essential protection for your vehicle's sides from large obstacles.
- Sold in pairs.
- Maverick MAX: Not compatible with the Rear Aluminum Half Doors (715007972).

Intrusion Bars

Front Intrusion Bar

Maverick, Maverick MAX

■ **715002889** · Black
■ **715003435** · Can-Am Red



- Matches vehicle styling.
- Inside and outside anti-corrosion coating with durable powder coat finish steel intrusion bar.
- Tube design reduces obstructed lines of sight and blind spots for better visibility.
- Not compatible with windshields or Lonestar Racing Aluminum Roof.

Lonestar Racing Front Intrusion Bar

Maverick, Maverick MAX

■ **715003916** · Black



- Made of 1.5" (3.8 cm) diameter steel tubing with durable powder coat finish.
- Enhances the racing look of the vehicle.
- Compatible with Lonestar Racing Aluminum Roof and Aluminum Roofs.
- Not compatible with windshields.

Lonestar Racing Rear Intrusion Bar

Maverick (except X mr models),
Maverick MAX

■ **715003918** · Black



- Made of 1.5" (3.8 cm) diameter steel tubing with durable powder coat finish.
- Sleek styling enhances the vehicle's race-inspired look.
- Required for the installation of the Lonestar Racing Spare Tire Holder.
- Not compatible with LinQ mounted accessories and Pre-Filter in the cargo bed.

Other Accessories

Fender Flares

Maverick, Maverick MAX

715002973



- Extended fender flares made from injection-molded polypropylene.
- Keep mud and debris out of vehicle.
- Designed for quick and easy installation.
- Include front and rear extensions and mounting hardware.

Lonestar Racing Spare Tire Holder

Maverick, Maverick MAX 2021 & prior
(except X mr models)

■ **715003922** · Black



- Made of 1.5" (3.8 cm) diameter steel tubing with durable powder coat finish.
- Adjustable height to fit Can-Am tires up to 30 in.
- Requires Lonestar Racing Rear Bumper and Lonestar Racing Rear Intrusion Bar for installation.
- Cannot hold the Pro Armor Quickshot Wheel Jack and Off-Road Screw Jack.
- Wheel not included.
- Not compatible with the S&B Particle Separator and LinQ accessories intended for the rear of the vehicle.

Lonestar Racing Number Plate Holder

Maverick, Maverick MAX

715003943



- Includes a pair of sturdy aluminum number plates that mount on either side of the vehicle rear.
- Not compatible with LinQ Pivoting Rack.
- Numbered decals are available through SCS Unlimited.
- Styling enhances the vehicle's race-inspired look while adding a personal touch.
- Black background.

S3 Rear Pull Plate

Maverick, Maverick MAX 2021 & prior

■ **715004870** · Black
■ **715005233** · Can-Am Red



- Offers a solid place to hook onto in case towing is needed.
- Allows you to attach most straps and hooks.
- "S3 for Can-Am" branded.

LINQ: EASY ON, EASY OFF CARGO

MAVERICK'S LINQ ACCESSORIES

Mounting location and requirements

<ul style="list-style-type: none"> No tools needed: Quickly install and remove accessories by hand Equip your Can-Am for specialized tasks in no time Sturdy mounting system that holds up to the roughest terrain 	Standard Cargo Bed	LinQ Pivoting Rack 715008295/715008296	Adventure Roof Rack 715003868/715006225
LinQ Accessories with 16" Base <ul style="list-style-type: none"> LinQ anchors mounted 16 inches apart, center-to-center. Lower loading capacity than the LinQ with 36" base accessories. Can be used on Can-Am ATV and SxS vehicles, Can-Am Spyder and Ryker vehicles, Sea-Doo watercraft and Ski-Doo snowmobiles. 			
LinQ 4.2 Gal Cooler 295100698 • White 219400964 • Black	LinQ Anchor Adapter Kit 715004960	LinQ Anchor Adapter Kit 715004960	LinQ Base Installation Kit 715008125
LinQ Tool Kit 715006829			
LinQ Tool Box 715008111			
LinQ SR 5.5 Gal (21 L) Bag 860202449			
LinQ 4.5 Gal (17 L) Sport Bag 860202447			
LinQ Modular Box 715005494 • (10 L) 715007112 • (20 L) 715006830 • (30 L)			
LinQ Roll-Top Bag 715008110			
LinQ Accessories with 36" Base <ul style="list-style-type: none"> Mount on LinQ racks often used by Can-Am ORV vehicles. Higher loading capacity than the LinQ with 16" base accessories. Usage is limited to Can-Am ORV vehicles. 			
LinQ 12 Gal (45 L) Cargo Box 715003879	No further requirements	No further requirements	No compatibility
LinQ 23 Gal (86 L) Trunk Box 715004923	No further requirements *Not compatible if the LinQ Pivoting Rack is installed.		
LinQ 32 Gal (121 L) Trunk Box 715001748			
LinQ 11.5 Gal (43 L) Audio Cargo Box 715003018			
LinQ 8 Gal (30 L) Cooler Box 715004778 • Black 715004698 • Gray			
LinQ Premium Storage Bag by OGIO[®] 715002923 • Black	No further requirements		
LinQ Heavy Duty Basket 715001215			
LinQ Low Profile Basket 715004282			
LinQ Holders			
LinQ Gear Grips 715005340	No further requirements	No further requirements	Side wall installation LinQ Adapters 715003058
LinQ Tool Holder 715007358			

LinQ Accessories with 16" Base

LinQ Modular Box

Maverick, Maverick MAX

715005494 · (10 L)

715007112 · (20 L)

715006830 · (30 L)



- Allows stacking of other modular boxes to always have the right gear accessible.
- Always have the right box size to fit everything.
- Can be installed on any LinQ base with a 16" width.
- See table for installation location and requirements.

Thermal Insert for LinQ Modular Box (10 L)

Maverick, Maverick MAX

219401110



- Insulated liner.
- Fits very well in the LinQ Modular Box (10 L).
- Can contain seven 355 ml cans.
- Keeps ice cold for one day.
- Interior dimensions: 9" L x 17" W x 2½" H.

LinQ Tool Box

Maverick, Maverick MAX

715008111



- High precision injected HDPE construction provides rigidity and durability.
- 5 gal (19 L) maximum capacity.
- Weather-resistant, sealed and lockable cover.
- Easy one-second on/off tool-less system.
- All the benefits of LinQ—simple, fast and secure.
- See table for installation location and requirements.

LinQ Tool Kit

Maverick, Maverick MAX

715006829



- Includes:
 - Cutter pliers
 - Long-nose pliers
 - Locking pliers
 - Ratchet wrench ¾" drive
 - 6" ratchet extension
 - Integrated CVT belt storage location (belt not included)
 - Long-socket 19 mm ¾" drive - 6 pts
 - Socket 18 mm ¾" drive
 - Long-socket 17 mm ¾" drive - 6 pts
 - Socket 15 mm ¾" drive
 - Socket 13 mm ¾" drive
 - Socket 10 mm ¾" drive
 - Socket 8 mm ¾" drive
 - Socket Torx T40 ¾" drive
 - Socket Torx T30 ¾" drive
 - Socket Torx T20 ¾" drive
 - Breaker bar ¾" drive
 - Combination Wrench set:
 - Wrench 19 mm
 - Wrench 18 mm
 - Wrench 15 mm
 - Wrench 13 mm
 - Wrench 10 mm
 - Wrench 8 mm
 - See table for installation location and requirements.

LinQ 4.2 Gal (16 L) Cooler

Maverick, Maverick MAX

■ 219400964 · Black

■ 295100698 · White



- All the benefits of LinQ—simple, fast and secure.
- Rotomolded construction for exceptional rigidity and durability.
- Premium-quality foam insulation for optimal ice retention.
- Uses LinQ mounting system (Patent US 8777531 and US 8875830).
- Easy one-second on/off tool-less system.
- Can contain twenty 355 ml cans.
- Keeps ice cold for three days.
- Exterior dimensions: 13" L x 20" W x 10" H.
- Interior dimensions: 9" L x 17" W x 7" H.
- See table for installation location and requirements.

LinQ 4.5 Gal (17 L) Sport Bag

Maverick, Maverick MAX

860202447



- All the benefits of LinQ—simple, fast and secure.
- 17 liter (4.5 US gallon) capacity.
- Thermoformed bag base in HDPE (High Density Polyethylene) providing rigidity and durability.
- Rigid bottom, semi-rigid top.
- Easy one-second on/off tool-less system.
- See table for installation location and requirements.

SR 5.5 Gal (21 L) LinQ Bag

Maverick, Maverick MAX

860202449



- All the benefits of LinQ—simple, fast and secure.
- Semi-rigid expandable bag.
- 5.5 gal (21 L) capacity.
- Utilizes LinQ mounting system (Patent US 8777531 and US 8875830).
- Easy one-second on/off tool-less system.
- See table for installation location and requirements.

LinQ Roll-Top Bag

Maverick, Maverick MAX

715008110

- Fully waterproof roll-top dry bag will securely store and confine your equipment.
- LinQ mounted using heavy-duty rigid plastic base.
- High capacity storage solution (40 L).
- Bottom foam liner for additional equipment protection.
- Integrated handle for easy transportation on/off the vehicle.
- Dimensions: 14" L x 19" W x adjustable H.
- See table for installation location and requirements.

LinQ Accessories with 36" Base**LinQ 12 Gal (45 L) Cargo Box**

Maverick, Maverick MAX

715003879

- LinQ mounted for easy-on, easy-off installation.
- Holds cargo safely and securely while riding.
- See table for installation location and requirements.

LinQ 23 Gal (86 L) Trunk BoxMaverick (except X mr models),
Maverick MAX**715004923**

- LinQ mounted for easy-on, easy-off installation.
- Holds cargo safely and securely while riding.
- See table for installation location and requirements.

LinQ 32 Gal (121 L) Trunk BoxMaverick (except X mr models),
Maverick MAX**715001748** · (No rear tail light)

- Equipped with the LinQ system, the rear trunk box plugs in and out in seconds.
- 32 gal (121 L) load capacity with unobstructed space to maximize storage room and access to the trunk's interior.
- Made of injection-molded polyethylene, double walled in critical areas.
- The fully sealed lid protects your belongings from dust, moisture and the elements.
- No rear tail light.
- Trunk Box Panels available in many colors to match your vehicle (sold separately).
- See table for installation location and requirements.

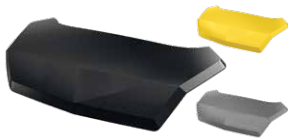
LinQ 32 Gal (121 L) Trunk Box PanelsFit with LinQ 32 Gal (121 L) Trunk Box
EUROPEAN VERSION (EC compliant)

- Color panels to match the LinQ 32 gal (121 L) Trunk Box to your vehicle.
- No rear tail light

- **715001397** · Black
- **715001398** · Yellow
- **715002483** · White
- **715006121** · Can-Am Red

- **715006122** · Manta Green
- **715006123** · Orange Crush
- **715006124** · Viper Red

LinQ 8 Gal (30 L) Cooler Box

Maverick, Maverick MAX

■ **715004778** · Black
■ **715004698** · Gray

- LinQ mounted for easy-on, easy-off installation.
- Rotomolded construction provides exceptional rigidity and durability.
- Premium-quality foam insulation for optimal ice retention.
- Integrated, fully removable compartment protects food.
- Robust rubber latches keep the cover tightly closed.
- Weather-resistant.
- Convenient drain plug.
- See table for installation location and requirements.

LinQ 11.5 Gal (43 L) Audio Cargo Box

Maverick, Maverick MAX

715003018

- An affordable and quick solution for adding music and storage to your next ride.
- The rear installation does not use up any cab space and allows easy listening at an average speed.
- Mounts on/off easily to hold/carry cargo safely and securely.
- Backlit control panel perfect for night riding.
- Water-resistant speakers.
- The Bluetooth[®] enabled receiver and 6.5" (16.5 cm) speakers are smartly concealed and integrated in the cover.
- Automatic shut-off function protects your battery by turning the system off after 10 minutes of inactivity.
- See table for installation location and requirements.

LinQ Heavy-Duty Basket

Maverick, Maverick MAX

715001215



- Made of high-strength, low-alloy steel.
- LinQ mount for easy-on, easy-off installation.
- See table for installation location and requirements.

LinQ Premium Storage Bag by OGIO

Maverick, Maverick MAX

■ 715002923 - Black



- Tool-less installation and removal thanks to the LinQ system.
- 17.2 gal (65 L) capacity semi-rigid cargo bag ideal for carrying anything you need on your vehicle.
- Buckle and elastic closure with a rubber seal that protects dust from entering the bag.
- 3-section lid for partial or full access to your bag.
- Inside separators for optimal bag organization.
- See table for installation location and requirements.

LinQ Low Profile Basket

Maverick, Maverick MAX

715004282



- Low profile, open basket increases cargo space.
- Perfect for easy access to tools, rope, winch and plow accessories.
- Multiple bungee cord and tie-down anchor points.
- Made of impact-resistant injected polypropylene.
- See table for installation location and requirements.

LinQ Holders

LinQ Tool Holder

Maverick, Maverick MAX

715007358



- Ultra-versatile tool holder.
- Convenient swivel-latch allows tools to be stored in any orientation.
- Sold in pairs.

LinQ Gear Grips

Maverick, Maverick MAX

715005340



- Durable and flexible grips provide a custom fit for a variety of items from 1" to 4" (2.5 cm to 10 cm) in diameter.
- Heavy-duty design for carrying bows, fishing poles, rakes, farm tools and more.
- Quick-release button opens grip quickly for easy access to gear.
- Heavy-duty base system built for the toughest adventures.
- Make transporting your tools a snap by combining the LinQ Gear Grips with the LinQ system.
- 360° orientation.
- Sold in pairs.

LinQ Mounting

LinQ Anchor Adapter Kit

Maverick, Maverick MAX

715004960



- Allows the installation of LinQ accessories with 16" base on LinQ racks.
- Tool-less installation and removal.

LinQ Base Installation Kit

Maverick, Maverick MAX

715008125



- Allows installation of compatible LinQ accessories.
- Included: 2 LinQ Cargo bases and hardware.

LinQ Lock

Maverick, Maverick MAX

860201968



- Simple way to securely lock most LinQ accessories.
- Lock cover protects lock from the elements.
- Corrosion resistant.
- Pack of 1, includes 2 keys.
- Not compatible with LinQ 4.2 US Gal (16 L) Cooler, LinQ Tool Box, LinQ Tool Holder or LinQ Gear Grips.

LinQ Replacement Part

Maverick, Maverick MAX

715001707



- Unique mounting fastener usable on any LinQ system accessory.
- Tool-less installation and removal.
- Sold in pairs.

LinQ Adapter

Maverick MAX

715003058



- Allows the installation of the LinQ Tool Holder on the Adventure Roof Rack.
- Sold in pack of 4.

Cargo Box Net

Maverick, Maverick MAX

715001371



- Solid net designed to secure and ensure the compact confinement of your Adventure Roof Rack.

Spare Tire Ratchet Tie-Downs

Maverick, Maverick MAX

280000955



- 3-way ratcheting tie-down strap with loop ends.
- Designed to securely hold spare tires on accessories equipped with integrated spare tire attachment points.
- Adjustable to accommodate most common UTV tire sizes.
- Ratchet and junction ring made of durable zinc-plated steel.
- Required for spare tire attachment on Adventure Roof Rack.

RACKS & STORAGE

Racks

LinQ Pivoting Rack

Maverick, Maverick MAX
(except X mr models)

■ 715008295 · Black
■ 715008296 · Can-Am Red



- LinQ latched rack allows for extra LinQ mounted accessories or for carrying a spare tire (tire not included).
- Includes custom tie-down strap for fast spare tire installation or removal (tire not included).
- Gas-cylinder pivot action, locks in the raised position.
- Trunk Boxes over 20 gal (74 L) do not fit on the vehicle when the rack is installed.
- Not compatible with Rear Intrusion Bars, Rear Cage Extension and Lonestar Racing Aluminum Roofs.

Adventure Roof Rack

Maverick
Maverick MAX

715006225

715003868



- Ideal cargo solution for packing everything you need to live your Off-Road experience fully and completely.
- Built with lightweight 1.25" (3.2 cm) diameter steel tubing.
- Integrated mounting points for lights can hold up to eight pod-type LED lights (six front and two back) or a 40" (102 cm) LED bar (front).
- Features anchor points for spare-tire attachment.
- LinQ anchor on both sides.
- Spare Tire Tie-Downs sold separately.
- Add the Cargo Box Net to secure and confine your cargo in the rack.
- Loads up to 75 lb (34 kg).

Adventure Roof Rack

Maverick
Maverick MAX

715007186
715008073



- The ideal cargo solution. Pack all the gear you need to take on any off-road experience.
- Built using lightweight 1.25" (3.2 cm) diameter steel tubing.
- Supports loads of up to 75 lb (34 kg).
- This roof rack features a height adjustment setting to precisely accommodate a stock roof.
- Integrated mounting points for lights.
- Features anchor points for a spare tire attachment.
- LinQ anchor on both sides.
- The Spare Tire Tie-Downs sold separately.
- Sport roof or Aluminum roof is required for installation.

Storage

Passenger Storage Seat Bag

Maverick, Maverick MAX

715008080



- This weather-resistant bag holds your gear safely and securely while you ride.
- Bag settling on the passenger seat to increase the vehicle's cargo capacity.
- This bag features a 14.5 gal (55 L) storage capacity and is divided into two compartments.
- The top compartment is insulated to keep your beverages cold and includes two cup holders.
- Additional pocket inside for additional storage, such as a cell phone.
- The bottom compartment is accessible from both sides and serves as a large pocket for storing various items.
- The detachable pocket at the front of the bag can be used as a garbage bag.

Shoulder Storage Bag

Maverick (except X mr models),
Maverick MAX (rear only)

715004277



- Bag attaches in unused space between the seats to increase your vehicle's cargo capacity.
- Installs between the rear seats only on MAX models.

Front Shoulder Storage Bag

Maverick MAX

715004888



- Opens on each side so that both front and rear passengers can access the bag's content.
- Installs between the driver and passenger seats on MAX models.

Overhead Storage Bag

Maverick, Maverick MAX

715004275



- Weather-resistant bag, holds your gear safely and securely while riding.
- Makes smart use of your overhead space to increase your vehicle's cargo capacity by 2.6 gal (10 L).
- Semi-rigid construction renders it flexible enough to fit odd-shaped loads.
- Touchscreen-compatible clear front pocket allows for easy access to your smartphone.
- Not compatible with the Bimini Roof.

Upper Door Storage Bags

Maverick, Maverick MAX

715004276



- Weather-resistant, they'll hold your gear safely and securely while riding.
- Bags attach on stock quarter doors to increase your vehicle's cargo space.
- Each bag is designed as a 1.3 gal (5 L) capacity pocket also equipped with inner netting compartments.
- Semi-rigid construction renders them flexible enough to fit odd-shaped loads.
- Sold in pairs.

Lower Door Panel Storage Bags

Maverick, Maverick MAX

715004355



- Weather-resistant, they'll hold your gear safely and securely while riding.
- Bags attach on Lower Door Panels to increase your vehicle's cargo space.
- Each bag is designed as a 1.6 gal (6 L) capacity pocket also equipped with inner netting compartments.
- Semi-rigid construction renders them flexible enough to fit odd-shaped loads.
- Sold in pairs.
- Not compatible with aluminum doors and Off-Road Screw Jack.
- Lower add-on doors required for installation.

Soft Storage Bag

Maverick, Maverick MAX

715003759



- 11.8 gal (45 L) capacity soft cargo bag designed with vehicle's rear in mind to maximize potential storage.
- 3 sections.
- Weatherproof.

Storage 2.6 Gal (10 L) Bag

Maverick, Maverick MAX

269502121



- Roll-top dry bag for fully protecting your cargo from the elements.

LIGHTS

		2 Choose your lights									
1 Choose your mount point		BAJA DESIGNS [†] LIGHTS					CAN-AM LIGHTS				
		10" (25 cm) LED Light Bar	40" (102 cm) Baja Design OnX6 Arc LED Light Bar	XL Sport LED Lights (sold in pairs)	Squadron Sport LED Lights (sold in pairs)	XL80 LED Lights (sold in pairs)	10" Double Stacked LED Bar	15" Double Stacked LED Bar	39" Double Stacked LED Bar	4" Round LED Lights (sold in pairs)	3.5" Spot or Flood LED Lights (sold in pairs)
Front Pre-Runner or Dune Bumpers	710006819 + 715007049 (Power Cable)	710006818 + 715007117 (Power Cable)	710006821 + 715002884 (Power Cable)	710006820 + 715002884 (Power Cable)	710005041 + 715007049 (Power Cable)	715002933 + 715003417 (Power Cable)	715002934 (Not compatible with Pre-Runner Bumper) + 715003417 (Power Cable)			715002935 (4" Round), 715009774 (3.5" Flood) or 715003666 (3.5" Spot) + 715003417 (Power Cable)	
Lonestar Racing Front Bumper		710006818 + 715007117 (Power Cable)	710006821 + 715002884 (Power Cable)	710006820 + 715002884 (Power Cable)	710005041 + 715007049 (Power Cable)						
Light Support Bar or Adventure Roof Rack	NA	710006818 + 715007117 (Power Cable)	710006821 + 715002884 (Power Cable)	710006820 + 715002884 (Power Cable)	710005041 + 715007049 (Power Cable)		715002934 + 715003417 (Power Cable)	715004007 + 715005822 (Light Mounting Kit)			
Lonestar Racing 40" (102 cm) LED Light Bar Rack		710006818 + 715007117 (Power Cable)	NA	NA	NA	NA	NA	NA	NA	NA	NA
Lonestar Racing Light Rack		NA	710006821 + 715002884 (Power Cable)	NA	710005041 + 715007049 (Power Cable)						

3 Order **Order all part numbers in intersecting box**
**Note: When installing more than one light kit, additional light power cable or mounting kit is required.*

*All lights are intended for off-road use only.

Lights Power Cable <i>(Not illustrated)</i>		715003417
		715007049
		715002884
		715007117

Maverick, Maverick MAX

- Required for installation of Baja Designs LED lights onto roof or bumper.
- 10" (25 cm) Baja Designs OnX6 LED Bars and Baja Designs XL80 LED Lights (715007049).
- Baja Designs XL Sport LED Lights and Baja Designs Squadron Sport LED Lights (715002884).
- 40" (102 cm) Arc LED Light Bar ONX6 (715007117).

40" (102 cm) Baja Designs OnX6 Arc LED Light Bar

Maverick, Maverick MAX

710006818



29,000 lumens

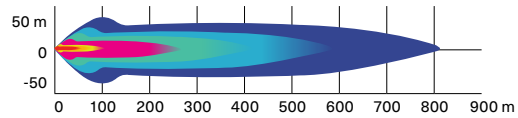

- 252 W light bar producing 29,000 lumens.
- Equipped with 24 Cree XM-L2 LEDs.
- Driving/combo light pattern for smooth blend of light for both near field applications and distance.

- Designed for installation onto Light Support Bar equipped roofs.
- Requires Light Power Cable and Light Support Bar.
- See table for installation location and requirements.

Baja Designs 10" (25 cm) OnX6 LED Light Bar

Maverick, Maverick MAX

710006819



12,460 lumens

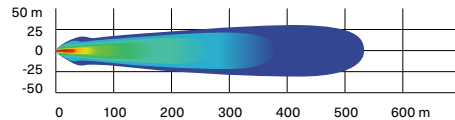

- 108 W light bar producing 12,460 lumens.
- Equipped with 6 Cree XM-L2 LEDs.
- Driving/combo light pattern for smooth blend of light for both near field applications and distance.

- Dual intensity (high/low) settings.
- Requires Baja Designs Light Power Cable.
- See table for installation location and requirements.

Baja Designs XL80 LED Lights

Maverick, Maverick MAX

710005041



9,500 lumens

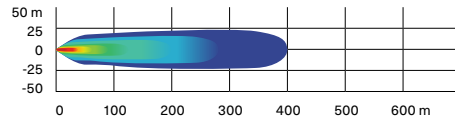

- 80 W per spot producing 9,500 lumens.
- Equipped with 4 Cree XHP50 LEDs per spot.
- Dual intensity (high/low) settings.
- Driving/combo light pattern for smooth blend of light for both near field applications and distance.

- Require Baja Designs Light Power Cable.
- Sold in pairs.
- Dimensions: 4.5" x 4.5" (11.4 cm x 11.4 cm).
- See table for installation location and requirements.

Baja Designs Squadron Sport LED Lights

Maverick, Maverick MAX

710006820



3,150 lumens

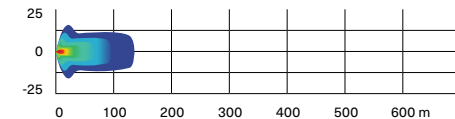

- 26 W per spot producing 3,150 lumens.
- Equipped with 4 Cree XP-G2 LEDs per spot.
- Wide cornering light pattern designed specifically for cornering, dust and/or fog conditions.

- Require Baja Designs Light Power Cable.
- Sold in pairs.
- Dimensions: 3" x 3" (7.6 cm x 7.6 cm).
- See table for installation location and requirements.

Baja Designs XL Sport LED Lights

Maverick, Maverick MAX

710006821



3,150 lumens

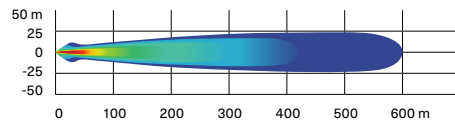

- 26 W per spot producing 3,150 lumens.
- Equipped with 4 Cree XP-G2 LEDs per spot.
- High Speed Spot features a longer and narrower beam focus for illumination farther down.

- Require Baja Designs Light Power Cable.
- Sold in pairs.
- Dimensions: 4.5" x 4.5" (11.4 cm x 11.4 cm).
- See table for installation location and requirements.

10" (25 cm) Double Stacked LED Light Bar (60 W)

Maverick, Maverick MAX

715002933



5,400 lumens

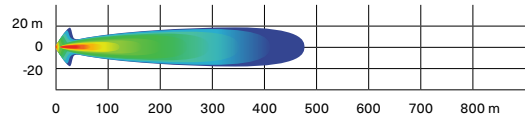

- Equipped with twelve 5 W Cree LEDs.
- 5,400 lumens.
- Packs a big punch for its size.
- Rugged and waterproof.
- Requires light power cable for installation.

- Lights up to more than 1,500 ft. (460 m) in front of the vehicle and around 65 ft. (20 m) wide on each side.
- See table for installation location and requirements.

15" (38 cm) Double Stacked LED Light Bar (90 W)

Maverick, Maverick MAX

715002934



8,400 lumens

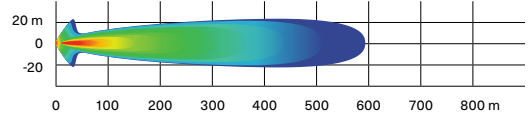

- Equipped with 18 5 W Cree LEDs.
- 8,400 lumens.
- Complements the Light Racks and most bumpers.
- Rugged and waterproof.

- Lights up to more than 1,900 ft. (580 m) in front of the vehicle and around 65 ft. (20 m) wide on each side.
- See table for installation location and requirements.

39" (99 cm) Double Stacked LED Light Bar (270 W)

Maverick, Maverick MAX

715004007



24,300 lumens

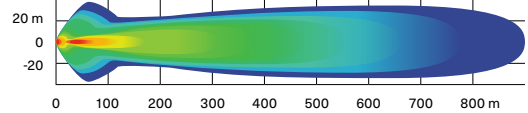

- Equipped with 54 5 W Cree LEDs.
- 24,300 lumens.
- Lights up to more than 2,900 ft. (900 m) in front of the vehicle and around 115 ft. (35 m) wide on each side.

- Compatible on the Adventure Roof Rack.
- Requires light power cable for installation.

4" (10 cm) Round LED Lights (2 x 25 W)

Maverick, Maverick MAX

715002935



1,800 lumens

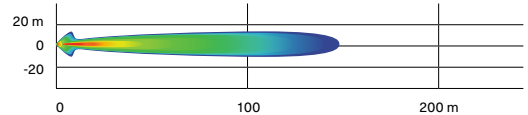

- 25 W LED spotlights.
- 1,800 lumens.

- Rugged and waterproof.
- Includes basic wiring and switch.

- Can-Am branded grill.
- Requires light power cable.
- Sold in pairs.

- Not EC compliant.
- Requires light power cable for installation.

3.5" (9 cm) LED Driving Lights (2 x 14 W)

Maverick, Maverick MAX

715009775



1,260 lumens

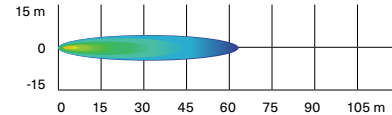

- 14 W LED lights producing 1,260 lumens each.
- Spot lens for a narrow and long light beam spread, ideal when driving at higher speeds.
- Equipped with six high-power LEDs in a heavy-duty die-cast aluminum housing.

- Features two attachment points. If one attachment point fails due to a collision, rotate to the next channel point and remount the light.
- Sold in pairs.
- ECE certified.
- Requires light power cable for installation.

3.5" (9 cm) LED Flood Lights (2 x 14 W)

Maverick, Maverick MAX

715009774

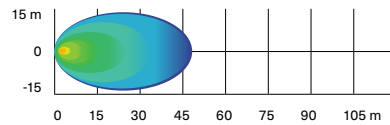

- 14 W LED lights producing 1,260 lumens each.
- Flood lens for a wide light beam spread, ideal for working applications like plowing or cornering. Suitable for dusty or foggy riding conditions.
- Equipped with six high-power LEDs in a heavy-duty die-cast aluminum housing.
- Features two attachment points. If one attachment point fails due to a collision, rotate to the next channel point and remount the light.
- Sold in pairs.
- ECE certified.
- Requires light power cable for installation.

Integrated LED Side Mirror Lights

Maverick, Maverick MAX

715007185



- Light up corners.
- Increase the width of the beams and illuminate the wheels for increased visibility.
- Wide flood beam.
- 3,000 lumens for each light.
- Require Aluminum Side Mirrors (715007363).
- Wiring Harness (715008212) is required for installation.

Can-Am LED Signature Lights

Maverick, Maverick MAX

715003673



- Add style with a more aggressive look.
- Use bright and energy efficient LEDs.
- Do not give additional lighting for driving.

Dome Light

Maverick, Maverick MAX

715002455



- LED array integrates perfectly with vehicle.
- Wiring included.
- Can be installed on cage, Sport Roof or All-Terrain Trunk Cover.

Lonestar Racing 40" (102 cm) LED Light Bar Rack

Maverick, Maverick MAX

715003920



- Designed for use with 40" (102 cm) Baja Designs OnX6 Arc LED Light Bar.
- Enhances the vehicle's race-inspired look.
- Compatible with Aluminum Roof, Lonestar Racing Aluminum Roof and Sport Roof.
- Not compatible with Racing Side Mirrors and PowerFlip Windshield.
- Lights sold separately.

Lonestar Racing Light Rack

Maverick, Maverick MAX

715003948



- Designed for use with Baja Designs XL80 LED Light and Baja Designs XL Sport LED Light.
- Accommodates up to two pairs of XL Lights.
- Not compatible with Racing Side Mirrors and PowerFlip Windshield.
- Compatible with Lonestar Racing Aluminum Roof, Aluminum Roof and Sport Roof.
- Lights sold separately.

Chase Lights

Maverick, Maverick MAX

715002887



- Designed by Can-Am to make you visible to vehicles riding behind you, especially in dusty or harsh conditions.
- Feature in-dash switches to activate one of the two modes and to choose among 11 different high-visibility colored light patterns (blue, red and yellow).
- Trail Mode: Serves as a tail light and as a brake light.
- Chasing Mode: Displays amber and blue light patterns and serves as a brake light (brake light function can be deactivated for racing applications).
- Modular to allow installation with rear roll cage mounted accessories.
- Plug-and-play installation.
- Verify your local regulations concerning the use of blue lighting.

LED Chase Lights

Maverick, Maverick MAX

715009887



- Designed by Can-Am to make you visible to vehicles riding behind you, especially in dusty or harsh conditions.
- High-visibility colored light patterns (red, yellow, white).
- Three modes available:
 - Trail Mode: serves as a tail light and as a brake light.
 - Chasing Mode: displays amber light pattern.
 - Work Mode: white light to light up your cargo bed.
- Modular to allow installation with rear roll cage mounted accessories.
- Plug-and-play installation.
- Wiring harness required (715008210).
- Sold separately.

Light Support Bar

Maverick, Maverick MAX

715003529



- Sleekly styled rugged aluminum construction.
- Accommodates light bars and spotlights with or without any roof and windshield combination.
- Full vehicle width to allow the installation of any large LED light bar.
- Required for light installation on vehicle's roof.
- Not compatible with Lonestar Racing Aluminum Roof.
- Lights sold separately.

Mounting Kit for 39" (99 cm) LED Light Bar

(Not illustrated)

Maverick, Maverick MAX

715005822

- Required for installation of the 39" (99 cm) double stacked LED Light Bar.
- Includes wiring and support bracket.
- Light Support Bar required for installation.

Light Power Cable

(Not illustrated)

Maverick, Maverick MAX

715003417

- Required for installation of 10" (25 cm), 15" (38 cm) and Double Stacked LED Light Bars and 4" (10 cm) Round LED Lights.
- For bumper and roof mounting locations.

AUDIO & COMMUNICATION SYSTEMS

Audio

Can-Am Audio Roof

Maverick

715007130



- Full roof with sleek built-in audio.
- Fully sealed and waterproof.
- Easy to install: one wire connects the roof to the vehicle's electronics.
- Four 8" speakers, one 400 RMS and 800 peak watt amplifier, and one Head Unit supplied by Rockford Fosgate Audio.
- Multi-colored RGB LED accent lighting around each speaker.
- 2.7" color display with Bluetooth and Pandora connectivity.
- Flip Kit-compatible.
- Not compatible with the Adventure Roof Rack if the Flip Kit is installed.
- Not compatible with the Upper Soft Door Panels.

Can-Am Audio Roof

Maverick MAX

715006709



- Full roof with built-in audio.
- Fully sealed and waterproof.
- Easy to install, one wire connects the roof to the vehicle's electric system.
- Six 8" speakers, one 400 RMS and 800 peak watt amplifier, one Head Unit calibrated by Rockford Fosgate Audio.
- Multi-colored RGB LED accent lighting around each speaker.
- 2.7" color Display with Bluetooth and Pandora connectivity.
- Not compatible with the Adventure Roof Rack if the Flip Kit is installed.
- Not compatible with the Upper Soft Door Panels.

Can-Am Audio Roof Flip Kit

Maverick, Maverick MAX

715007131



- Combines with Audio Roof (715007130 or 715006709) for Flip option.
- Not compatible with the Racing Side Mirrors (715002898).

MTX Central Speakers

Maverick MAX

715004748



- Top mounted central speaker case holding two 6.5" (16.5 cm)/100W speakers.
- Designed to be Can-Am-tough in the most demanding riding conditions.
- Perfect add-on to the Complete MTX Audio System for a 7-speaker system or as a stand-alone system by plugging the AUX input jack directly into your music device.
- Not compatible with Lonestar roofs.

Complete MTX Audio System	Maverick, Maverick MAX	715002873
----------------------------------	------------------------	------------------



- Bluetooth 5¹ equipped 400 W RMS/800 W peak audio system by MTX.
- Designed to be Can-Am-tough in the most demanding riding conditions.
- Includes front-dashboard and rear-roll-cage mounted stereo speakers and head unit with an integrated 6.5" (16.5 cm) subwoofer.
- Add the Electronic Device Holder to securely hold your Bluetooth device ready to play your favorite tunes.

Can-Am Subwoofer	Maverick, Maverick MAX	715004956
-------------------------	------------------------	------------------



- Powerful Rockford Fosgate Underseat 10" Subwoofer speaker box.
- Easy plug-and-play connections to Audio Roof system.
- Sturdy construction tough enough to withstand harsh environments and sealed against moisture and dirt.
- Requires 1 Amplifier Kit (715007227) for 1 or 2 subwoofers.
- Fits two per vehicle: under driver or passenger seat.

Can-Am Amplifier Kit	Maverick, Maverick MAX	715007227
-----------------------------	------------------------	------------------



- A powerful 400 W amplifier to feed up to two Underseat Subwoofers.
- Easy plug-and-play connections to Audio Roof system and subwoofer.
- Installation plate and wiring included.

Electronic Device Holder	Maverick, Maverick MAX	715002874
---------------------------------	------------------------	------------------



- A great in-ride entertainment system platform.
- Robust injected-polypropylene construction allows for right fit and easy installation.
- Adjustable unit safely holds most tablets and smartphones measuring between 5.1" (13 cm) and 10" (25.4 cm) (with protective case).
- Combines seamlessly with Complete MTX Audio System and Rugged Radios Intercom System.
- Allows the installation of Garmin Montana 680T GPS.
- Integrated storage (1 gal [3.8 L] capacity) with access to the dash 12V outlet for device charging.

Communication Systems

Rugged Radios Helmet Headset Kit for Rear Passengers	With Rugged Radios Intercom System	715004380 · US ONLY
---	------------------------------------	----------------------------



- Additional 12' (3.7 m) cables and Helmet Speaker/Mic Kits to upgrade your 2-person intercom system to a 4-person system.
- Power Cable is required for installation on MAX models.

ELECTRICAL & ELECTRONIC ACCESSORIES

Electrical

Seat Heater	Maverick, Maverick MAX	715006112
--------------------	------------------------	------------------

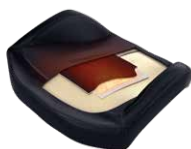

- 25 W seat heater delivers chill-free riding comfort.
- High/low temperature settings allow you to control the desired degree of warmth.
- This kit includes one carbon fiber seat heater, foam sheet and in-dash switch.
- Installs directly in the original seat cushion.
- Heated Accessories Wiring Harness (710005757) is required for front seat installation.
- Heated Accessories Wiring Harness (715006004) is required for rear seat installation.

Heated Visor Outlet	Maverick, Maverick MAX	715001246
----------------------------	------------------------	------------------



- Strategically positioned on vehicle to maintain your agility.
- Optional visor outlet that delivers fog-free riding.
- Quick and easy installation.
- Sold individually.
- Heated Visor not included.

Heated Accessories Wiring Harness

(Not illustrated)

Maverick, Maverick MAX

710005757

- Electric harness required to hook up and operate front heated seats, heated steering wheel and heated grab bar.
- Heated Accessories Wiring Harness (715006004) is required for rear seat installation.

Auxiliary Battery Installation Kit

(Not illustrated)

Maverick, Maverick MAX

715006315

- Allows you to add a second 18Ah battery for a dual battery setup necessary to power auxiliary electrical components such as sound systems or winches.
- Equipped with an IP67-rated waterproof electronic module that will prevent your auxiliary electrical components from draining your starting battery.
- Kit includes an additional battery junction block, all necessary wiring and the battery holder.
- Both batteries are perfectly integrated, in stock location, behind the passenger seat.
- Additional battery (410301203), plus battery hardware (250000282) sold separately.

Electronic

Cellphone Holder

Maverick, Maverick MAX

715008786



- Water resistant door allows for perfect phone positioning.
- Features capacitive and resistive touch screen technology.
- Spring system in back plate automatically adjusts for thickness.
- Fits all cellphones within 7.2" (185 mm) x 3.3" (85 mm) x 0.6" (15 mm) dimensions.
- Works with almost all charger wires.
- Does not include cellphone or charging wires.
- Requires the Electronic Device Holder (715002874) for the Cellphone Holder to be bolted on its door.

Lighted Whip Flag

Maverick, Maverick MAX

715002886



- A must for riding the dunes.
- 5 W Cree LED.
- 5 colored lenses to allow personalization.
- Glow-through whip, quickly removable and replaceable pole.
- Increases vehicle's visibility.
- Meets most dune-area requirements.
- Die cast aluminum base, acetal hand nut.
- Includes mounting brackets and wiring.
- 4' (1.2 m) flag mounts on top of the roll cage.
- Can be installed on both sides of a vehicle.

Digitally Encoded Security System (D.E.S.S.) Green Key

Maverick
(Turbo/TurboR/Turbo RR motorization)

710005232



- Top-security anti-theft protection for your vehicle.
- Encrypted chip technology restricts access to your vehicle's electronic ignition system.
- One vehicle/one code.
- A vibration/shock-resistant ball-and-socket design that ensures a reliable connection.
- 2 programmable modes:
 - Normal mode: Limits vehicle speed to 70 kph (44 mph) and 50% torque reduction.
 - Performance mode: No restrictions.

WINCHES & HITCHES

Can-Am HD Winches

Can-Am HD 4500 Winch

Maverick, Maverick MAX

715006416



- Ergonomic clutch handle.
- Rugged all-steel gears and bushings for more torque and durability.
- Automatic 100% load-holding brake.
- Sealed solenoid for all-weather protection.
- Weather sealed corded remote and dash mounted switch.
- EC compliant.
- Pulling strength capability of 4,500 lb (2,041 kg).
- 43' of 1/8" (13.1 m of 6.3 mm) wire steel cable.
- Heavy-duty 4-way roller fairlead.
- Winch Electrical Harness (715003585) and winch compatible front bumper are required.

Can-Am HD 4500-S Winch

Maverick, Maverick MAX

715006417



- Ergonomic clutch handle.
- Rugged all-steel gears and bushings for more torque and durability.
- Automatic 100% load-holding brake.
- Sealed solenoid for all-weather protection.
- Weather-sealed corded remote and dash mounted switch.
- Pulling strength capability of 4,500 lb (2,041 kg).
- 50' of 1/4" (15.2 m of 6.35 mm) synthetic rope.
- Corrosion-proof aluminum hawse fairlead.
- Winch Electrical Harness (715003585) and winch compatible front bumper are required.

WARN⁺ VRX Winches

WARN VRX 45 Winch

Maverick, Maverick MAX

715006110



- Extreme IP68-rated waterproof sealing keeps the elements out.
- Durable all-metal construction.
- Black powder-coated finish and stainless steel fasteners for corrosion resistance.
- Robust new clutch design based on 70+ years of WARN 4 WD hub lock know-how.
- Load-holding brake for great control.
- Smooth and reliable all-metal three-stage planetary gear train.
- Dash-mounted rocker control.
- Limited lifetime warranty (mechanical), 3-year warranty (electrical).
- Pulling strength capability of 4,500 lb (2,041 kg).
- 50' of 1/4" (15 m of 6.3 mm) wire steel cable.
- Roller fairlead.
- Winch Electrical Harness (715003585) and winch compatible front bumper are required.

WARN VRX 45-S Winch

Maverick, Maverick MAX

715006111



- Extreme IP68-rated waterproof sealing keeps the elements out.
- Durable all-metal construction.
- Black powder-coated finish and stainless steel fasteners for corrosion resistance.
- Robust new clutch design based on 70+ years of WARN 4 WD hub lock know-how.
- Load-holding brake for great control.
- Smooth and reliable all-metal three-stage planetary gear train.
- Dash-mounted rocker control.
- Limited lifetime warranty (mechanical), 3-year warranty (electrical).
- Pulling strength capability of 4,500 lb (2,041 kg).
- 50' of 1/4" (15 m of 6.3 mm) synthetic rope.
- Cast aluminum hawse fairlead.
- Winch Electrical Harness (715003585) and winch compatible front bumper are required.

Winch Accessories

Can-Am HD Hawse Fairlead

Can-Am HD Winch

715006426



- A must when upgrading your winch with a synthetic cable, this corrosion-proof aluminum hawse fairlead will prevent the cable from snapping in a corner of a roller fairlead and from wearing prematurely due to the rough surface of the worn roller guide.
- Must be used with synthetic cables only.

WARN Hawse Fairlead

WARN Winch

715007785



- Double-powder-coated construction.
- To be used with synthetic winch cables only.

Synthetic Winch Cable	Can-Am HD Winch	715006430
	WARN Winch	715007783



- 50' of ¼" (15.2 m of 6.35 mm) synthetic cable for Can-Am HD winches.
- Can-Am HD Hawse Fairlead (715006426) is required when upgrading to a synthetic cable to avoid premature cable damage and wear.
- WARN Hawse Fairlead (715007785) is required when upgrading to a synthetic cable to avoid damage and premature wear of the cable.

Wire Rope Replacement	Can-Am HD Winch	705014978
	WARN Winch	715006699



- 43' of 15/64" (14.3 m of 6.3 mm) wire rope for Can-Am HD Winch.
- 55' of ¼" (16.8 m of 6.35 mm) wire rope for WARN winch kit.
- 4,500 lb (2,041 kg) pulling strength.

Synthetic Cable Extension	715001120
----------------------------------	------------------



- Lightweight ¼" (6.35 mm) diameter, easy to handle and won't rattle in cargo box.
- Easily attaches to winch cable to provide additional 50' (15.2 m) of distance.
- 4,500 lb (2,041 kg) single line capacity.

Winch Electrical Harness <i>(Not illustrated)</i>	Maverick, Maverick MAX	715003585
---	------------------------	------------------

- Required for winch installation.

Rear Winch Harness <i>(Not illustrated)</i>	715006007
---	------------------

- Required for installation of a winch on the S3 Rear Winch Bumper.

Wired Remote Control	Can-Am HD Winch*	715006504
-----------------------------	------------------	------------------



- This kit allows winch owners to add the hand-held remote to vehicles with a stock winch.
- OEM stock winch is sold separately.
- EC compliant.

† *Harness (710001023) is required to use remote control on a vehicle with a factory installed winch.*
‡ *Remote control (710007050) and connection socket are included.*

Wireless Remote Control	WARN Winch	715002542
--------------------------------	------------	------------------



- The system is quick and easy to install, thanks to a wiring harness with an integrated antenna and all necessary mounting hardware.
- The system allows you to operate your winch from anywhere within a 50' (15.2 m) radius, increasing your recovery options.
- All components are weatherproof.

X rc/X mr Rear Tow Hook	Maverick, Maverick MAX 2021 & prior	715004450
--------------------------------	-------------------------------------	------------------



- Offers a solid place to hook onto in case towing is needed.
- Allows you to attach most straps and hooks.
- Made of rugged 3/8" (5 mm) steel plate and 5/8" (16 mm) steel hook tube.
- Standard on Maverick X rc and X mr models.

Hitches

Rear Hitch	Maverick, Maverick MAX 2021 & prior	■ 715002883 - Black
		■ 715003938 - Can-Am Red



- Rugged lightweight steel construction.
- E-coated finish.
- Fixed mounting point for trailer ball to provide vehicle with towing capabilities.
- This hitch offers 1,300 lb (590 kg) of towing capacity.
- Hitch ball not included.

Front and Rear Hitch Drawbar	Maverick, Maverick MAX	715008350
-------------------------------------	------------------------	------------------



- Standard on 2" (5 cm) receiver hitch.
- It offers 1,650 lb (750 kg) of towing capacity.
- Hitch ball not included.
- Forged steel.

PERFORMANCE

Smart-Lok Technology

Smart-Lok Differential

Maverick produced after January 1, 2017
Maverick MAX

705402936



- Can-Am-exclusive Smart-Lok technology constitutes a true fully lockable on-the-fly front differential with electronically controlled automatic modes.
- Choose your differential settings according to your riding need: "2x4" for rear wheel traction only, "4x4 Front Diff Lock" for a fully locked 4 wheel drive, and "4x4 Smart Mode" that offers preset, intelligent calibrations for your type of riding.
- Using multiple input sources, "Smart Mode" will instantaneously engage locking with the right load at the right moment to procure maximum traction while retaining low-speed maneuverability, allowing for optimal placement and a feeling of confidence.
- The Smart-Lok Differential Kit comes standard with the Trail Mode.
- Mud, Rock and Trail Activ modes can be added by installing an additional Smart Mode Module (sold separately) to fine-tune your riding environment.
- Requires Performance Half Shafts (2x) and Smart-Lok Installation Kit for installation.

Performance Half Shaft

Maverick, Maverick MAX
Maverick, Maverick MAX

705401634 · 64"
705402048 · 72"



- High-performance design ideal for off-road use, with superior protection in any riding usage.
- Includes CVs, shaft and boots with the best suited geometry for your Can-Am vehicle.
- Required to install the Smart-Lok Differential Kit.

Mud Smart Mode Module

(Not illustrated)

Maverick, Maverick MAX with Smart-Lok
Differential
(except Turbo RR models 2021 & up)

715005282

- This module allows you to add the Mud Smart Mode to vehicles with the Smart-Lok Differential Kit sold as an accessory or to change to the Mud Smart Mode on vehicles equipped with a standard Smart-Lok.
- The Mud Mode has been specially designed to deliver superior traction in the deepest mud holes.
- When high engine torque and/or slippage is detected, Smart-Lok will fully lock the front end.
- The system will stay locked until throttle release.
- Only one Smart Mode Module can be installed at a time.

Rock Smart Mode Module

(Not illustrated)

Maverick, Maverick MAX with Smart-Lok
Differential
(except Turbo RR models 2021 & up)

715005283

- This module allows you to add the Rock Smart Mode to vehicles with the Smart-Lok Differential Kit sold as an accessory or to change to the Rock Smart Mode on vehicles equipped with a standard Smart-Lok.
- The Rock Mode has been specially designed to help cross challenging rocks.
- When high engine torque is detected at low vehicle speed, Smart-Lok will progressively lock the front end and will stay engaged until throttle release to prevent wheel slippage and provide optimal traction.
- The progressive engagement allows for easier steering when maneuvering the vehicle.
- Only one Smart Mode Module can be installed at a time.

Trail Activ Smart Mode Module

(Not illustrated)

Maverick, Maverick MAX with Smart-Lok
Differential
(except Turbo RR models 2021 & up)

715005284

- This module allows you to add the Trail Activ Smart Mode to vehicles with the Smart-Lok Differential Kit sold as an accessory or to change to the Trail Activ Smart Mode on vehicles equipped with a standard Smart-Lok.
- The Trail Activ mode has been designed for aggressive riding, delivering the ultimate cornering precision.
- When high engine torque and/or an increase in vehicle speed is detected, Smart-Lok will progressively engage the front end and maintain it engaged until throttle release or vehicle speed reduction.
- The progressive engagement allows for smoother and lower steering effort.
- Only one Smart Mode Module can be installed at a time.

Lonestar Racing Mud Flaps with Brackets

Maverick, Maverick MAX

715004865



- These bolt-on mud flaps make a great addition.
- Durable chromoly brackets.
- Protect trailing arms, rotors and CVs from rocks and debris.
- Sold in pairs.
- Incompatible with HMWPE Front A-Arm And Trailing Arm Protector (715002905 and 715003552).

Lonestar Racing Heavy-Duty Shift Plate & Knob

Maverick, Maverick MAX

715004866

- The shift plate is made from durable stainless steel and bolts into place for a secure fit.
- The kit comes with a billet aluminum Lonestar Racing shift knob.
- Offers improved durability for the performance-oriented driver.

Lonestar Racing Outer Toe Link Boxed Gusssets Roller Fairlead

Maverick, Maverick MAX 2021 & prior

715004868

- Protects and strengthens the middle radius rod links from rough riding conditions.
- Includes high-grade steel bolts.

Lonestar Racing Quick Release Clutch Cover Pins

Maverick, Maverick MAX

715005045

- This kit will allow you to take off your clutch cover in seconds to access the belt tool-lessly.
- Includes 4 stainless steel "quick release" pins with clips and tethers.
- Replaces all clutch cover screws.
- This product affects the clutch cover sealing. It is highly recommended to use this product under dry riding conditions only.

Lonestar Racing Heavy-Duty Rear Boxed Radius Rod Support Plate

Maverick, Maverick MAX 2021 & prior

715005046

- Double-layered radius rod support plate made of high-grade steel.
- Reinforces your rod mounting location on the frame while adding a mean racing look to your vehicle.
- Easy to install.

Yoshimura[†] Slip-on Exhaust

Maverick, Maverick MAX

715002882

- Developed in collaboration with Yoshimura.
- Made from 304-grade stainless steel with brushed aluminum tip.
- Better sounding, better looking and 19% lighter than stock muffler.
- USDF/USDA approved spark arrester.
- Fuel injection system tuning not required.
- ROHVA and EPA compliant.
- Not EC compliant.

Performance Air Filter by Twin AIR[†]

Maverick, Maverick MAX

715002895

- The best choice for the harshest conditions.
- Multiple staged oiled filtering foam for superior dust retaining capacity with high airflow.
- Washable and reusable.

Snorkel Pre-Filter

Maverick, Maverick MAX (with Snorkel Kit)

715005599

- Pre-filter specifically for snorkels.
- Adds extra protection to your engine in harsh riding conditions.
- Helps keep air filter cleaner.
- Filter blocks particles larger than 0.005" (0.13 mm).
- Necessary to maintain vehicle warranty when tracks are installed.

Snorkel Kit	Maverick, Maverick MAX (2019 and prior)	715003733
	Maverick, Maverick MAX (2020 & up)	715007110



- Raises point of engine and CVT air intakes so vehicle can be semi-submersed in water or mud without the engine taking in water.
- Not compatible with S&B Particle Separator, LinQ Pivoting Rack, Lonestar Racing Rear Intrusion Bar or any rear panels or windows.
- Sealed Air Box 707800780 (sold separately) is required for installation on models manufactured before January 1, 2018.
- Standard on Maverick X mr models.
- Not EC-compliant.
- No fit on all models equipped with remote shock reservoir mounted on C-pillar.

Radiator Relocator	Maverick, Maverick MAX	715004937
---------------------------	------------------------	------------------



- Relocates stock radiator to rear of cage.
- Protects it from debris and rocks.
- Prevents cooling performance loss in muddy conditions.
- Reduces hot air in the cabin.
- Easy to clean.
- Includes support hardware and hoses.
- Not compatible with any bed accessories, Rear Cage mounted accessories, Complete MTX Audio system and Upper Soft Doors (except LinQ 8 gal [30 L] Cooler Box).
- Radiator (709200703) is required for installation on 2017 models.
- Not compatible with full windshield.

WARNING: Any modifications or addition of accessories may affect the handling of your vehicle. It is important to take the time to get familiar with the vehicle once modifications are made to understand how to adapt your driving behavior accordingly. Do not tamper with unauthorized modifications or install equipment not specifically certified by BRP for the vehicle. These modifications have not been tested by BRP and they may increase the risk of injury or loss of control, or render the vehicle illegal to ride. Ask your authorized BRP dealer for suitable available accessories for your vehicle.

850 W Magneto Kit	Maverick, Maverick MAX (2021 & up)	715006279
--------------------------	------------------------------------	------------------



- Increases the magneto output to 850 W.
- Includes rotor, stator and regulator.

172 HP Intercooler Upgrade Kit <i>(Not illustrated)</i>	Maverick, Maverick MAX (2018 and 2019)	715007137
---	--	------------------

- Intercooler upgrade for the Maverick 2018 & up.
- Installation must be done by an authorized BRP dealership to preserve the vehicle's warranty.
- Requires the Power Upgrade Installation Kit (715007111).

Emergency Accessories

Lonestar Racing Fire Extinguisher Support	Maverick, Maverick MAX	715007320
--	------------------------	------------------



- Quick-release support that lets riders slide the fire extinguisher out in a matter of seconds in an emergency.
- Made of billet anodized black aluminum.
- Fits 1.85" (4.7 cm) tubing.
- Can be fixed anywhere on the cage.
- Provides riders with the safety and security of knowing they have dependable emergency equipment on board.
- Comes with both billet mounts, quick-pull pin, mounting plate and two clamps.
- Fire extinguisher sold separately.
- "Lonestar Racing for Can-Am" branded.

Fire Extinguisher	295100833
--------------------------	------------------



- Ideal for grease, oil and electrical fires.
- Fits with Lonestar Racing Fire Extinguisher Support Kit.
- Not EC compliant.
- Not available in Europe.

Emergency Kit	Maverick, Maverick MAX	715006102
----------------------	------------------------	------------------



- Complete emergency kit provides all essential equipment and supplies to get out of most unfavorable situations powersport enthusiasts can find themselves in.
- Includes: jumper cables, air compressor, tire repair kit, ratchet tie-down, duct tape, 3,300 lb (1,500 kg) tow strap, zip-ties, cloth rags.

WARNING: Any modifications or addition of accessories may affect the handling of your vehicle. It is important to take the time to get familiar with the vehicle once modifications are made to understand how to adapt your driving behavior accordingly. Do not tamper with unauthorized modifications or install equipment not specifically certified by BRP for the vehicle. These modifications have not been tested by BRP and they may increase the risk of injury or loss of control, or render the vehicle illegal to ride. Ask your authorized BRP dealer for suitable available accessories for your vehicle.

APACHE TRACK SYSTEMS

Winter Tracks

Limited Warranty*

Apache Backcountry LT Track System

Maverick, Maverick MAX

715004734



- Tracks designed to deliver the best snow performance on the market with unmatched flotation level and traction on snow surface.
- Large contact patch, 37% bigger than the Apache 360 LT.
- Impressive added ground clearance of 7" (18 cm) helps keep the vehicle over the snow.
- Lightweight snowmobile-inspired rail design.
- Aggressive track design with 2" (5 cm) lug height for maximum traction on snow.
- Apache Backcountry LT Mounting Kit, Track DPS Module and Engine and CVT Pre-Filter are required.
- Fine-tune your track system using extra Idler Wheels, Sliders with Vespel Inserts and Rail Ice Scratcher.
- For winter use only.
- Track installation will affect vehicle width and length.

Apache Backcountry LT Mounting Kit

(Not illustrated)

Maverick, Maverick MAX

715004397 · 64" models

715004394 · 72" models

- Required for installation of the Apache Backcountry Track LT System.
- DPS Module and Pre-Filter are required and sold separately.

Year-Round Tracks

Limited Warranty*

Apache 360 LT Track System

Maverick, Maverick MAX

715010085



- Multifunctional tracks designed to support heavy loads and to fit on most Can-Am off-road vehicles.
- Extra contact patch adjustment for better performance over rough terrain.
- Contact patch is 7 to 9% bigger than the Apache 360's.
- Average ground clearance of 16" (41 cm). 1" (2.5 cm) lugs in the front and 1.25" (3.2 cm) in the back.
- EC compliant.
- Apache 360 LT Mounting Kit, Track DPS Module and Engine and CVT Pre-Filter Kit are required and sold separately.
- Recommended for use on snow only.

Apache 360 LT Mounting Kit

(Not illustrated)

Maverick, Maverick MAX

715004392 · 64" models

715004393 · 72" models

- Required for installation of the Apache 360 LT Track System.
- Track DPS Module and Pre-Filter not included.

*The limited warranty is subject to the exclusions, limitations of liabilities and all other terms and conditions of BRP's standard limited warranty.

APACHE TRACK SYSTEMS FITTING GUIDE

Apache Backcountry LT

Model Year / Model	Track	Track Mount	Track DPS Module	Prefilter without Snorkel	Prefilter with Snorkel
2017 & Up Maverick, Maverick MAX (64" Models)	715004734	715004397	715007338 Maverick, Maverick Max 2022 & prior (except Turbo RR Engine) OR 715006266 Maverick, Maverick Max 2023, and 2022 & prior with Turbo RR Engines	715005600 (except X mr)	715005599
2017 & Up Maverick, Maverick MAX (72" Models)		715004394			

Apache 360 LT

Model Year / Model	Track	Track Mount	Track DPS Module	Prefilter without Snorkel	Prefilter with Snorkel
2017 & Up Maverick, Maverick MAX (64" Models)	715010085	715004392	715007338 Maverick, Maverick Max 2022 & prior (except Turbo RR Engine) OR 715006266 All Maverick, Maverick Max 2023 & up and 2022 & prior with Turbo RR	715005600	715005599
2017 & Up Maverick, Maverick MAX (72" Models)		715004393			

*The limited warranty is subject to the exclusions, limitations of liabilities and all other terms and conditions of BRP's standard limited warranty.

Apache Accessories

Rail Ice Scratchers

Apache Backcountry LT Track System

860201728



- Provide additional lubrication in hard and icy conditions.
- Rail mounted, small, light.
- Design expands on coil concept to allow reversing without damage.
- Easily stored when not in use.
- Extends slider life.

Apache Backcountry LT Wheel Kit

Apache Backcountry LT Track System

715006293



- Additional wheel kit for Backcountry LT rear tracks.
- Reduces drag and rolling resistance in hard snow conditions or when transporting heavier loads.
- Extends slider life in hard snow conditions.
- Includes two wheels, cross shaft and mounting hardware per kit to service one track corner.
- Up to two kits per rear track can be installed.

Sliders with Vespel[†] Inserts

Apache Backcountry LT Track Systems

503194815



- Use DuPont Vespel inserts for less friction.
- Longer life.
- Can be cut to desired length.
- 8 needed per vehicle.
- Sold individually.

Track DPS Module

(Not illustrated)

Maverick, Maverick MAX (Turbo RR Engine only)

715006266

Maverick, Maverick MAX (except Turbo RR Engine)

715007338

- Innovative DPS module that ensures speedometer accuracy and optimized steering assist, making for perfect track control and riding ease.
- Required to install the Apache Track Systems.
- See table for fit, compatibility and requirements.

Engine & CVT Air Intake Pre-Filter

Maverick, Maverick MAX (except X mr models)

715005600



- Adds extra protection to your engine in harsh riding conditions.
- Helps keep air filter cleaner.
- Filter blocks particles larger than 0.007" (0.19 mm).
- Easy installation.
- Not compatible with S&B Particle Separator.
- Necessary to maintain vehicle warranty when tracks are installed.

Required to install the Apache Backcountry LT and Apache 360 LT Track Systems.

PROMOUNT PLOWS

ProMount Plow Kits – Reference Charts

	72" Black Steel	72" Yellow Steel	72" Flex2
Plow Kit	715008176	715008177	715008175
Blade	715004474	715006021	715004485
Push Frame	715008116	715008116	715008116
Mounting Plate	715008197	715008197	715008197

Can-Am ProMount Steel Plow Kits

Can-Am ProMount Steel 72" (183 cm) Plow Kit

Maverick, Maverick MAX

- **715008176** · Black
- **715008177** · Yellow



- These kits include:
 - Can-Am ProMount Steel Blade
 - Push Frame with Quick-Attach System
 - Can-Am ProMount Mounting Plate

Can-Am ProMount Steel Blades

Can-Am ProMount Steel 72" (183 cm) Blade

Fits ProMount Push Frame

- **715004474** · Black
- **715006021** · Yellow



- Plow blade made from 12-gauge steel.
- Replaceable wear blade.
- Large pin designed for easy blade rotation to eliminate snow buildup at pivot point.
- Blade design provides best snow roll-off at any angle.
- Clears 66" (168 cm) when plow is fully angled.
- Blade height of 17" (43 cm).
- Compatible with Can-Am ProMount Blade accessories to further enhance plow versatility.
- Not compatible with S3 High Clearance Front A-Arm.

Can-Am ProMount Angle Plows

Can-Am ProMount 72" (183 cm) Steel Oneway State Blade

Fits ProMount Push Frame

715007264



- Make the job easier with the right tools, clear long alleys and make the task easier by sending the snow further out of the way.
- Wing end of plow measures 26" (67 cm) high and tapers down to 16" (41 cm).
- One-way "winged" state plow designed to throw snow higher.
- Rubber Flap (715007299) designed to keep snow away from the driver is offered as accessory (sold separately).
- Can-Am branded.

Can-Am ProMount Flex2 Plow Kit

Can-Am ProMount Flex2 72" (183 cm) Kit

Maverick, Maverick MAX

715008175



- These kits include:
 - Can-Am ProMount Flex2 Blade
 - Push Frame with Quick-Attach System
 - Can-Am ProMount Mounting Plate

Can-Am ProMount Flex2 Blades

Can-Am ProMount Flex2 72" (183 cm) Blade

Fits ProMount Push Frame

715004485



- Plow blade made of UHMWPE, flexible and impact absorbing material prevents damaging your plow when accidental impact occurs.
- Replaceable wear blade.
- Large pin designed for easy blade rotation to eliminate snow buildup at pivot point.
- Blade design provides best snow roll-off at any angle.
- Clears 66" (168 cm) when plow is fully angled.
- Blade height of 17" (43 cm).
- Compatible with Can-Am ProMount Blade accessories to further enhance plow versatility.

Can-Am ProMount Plow Accessories

Can-Am ProMount Edge Markers

Maverick, Maverick MAX

715004206

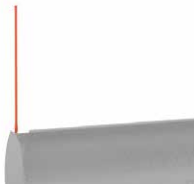

- Help locate the edges of your plow.
- Height: 24" (60 cm).
- Sold in pairs.
- Compatible with Can-Am ProMount Steel and Flex2 Blades with or without Blade Extensions (except for the Can-Am ProMount Steel 54" (137 cm) Blades).

Can-Am ProMount 72" (183 cm) Plastic Wear Blade

Maverick, Maverick MAX

715004483



- Ideal to prevent marks on your driveway.
- Compatible with Can-Am ProMount 72" (183 cm) Blades.

Can-Am ProMount Drift Cutters

Maverick, Maverick MAX

715006258

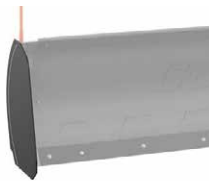

- Help keep snow in the plow.
- Dimensions: 17" x 13" (43.2 cm x 33 cm).
- Sold in pairs.
- Compatible with Can-Am ProMount Steel and Flex2 blades with or without Blade Extensions (except for the Can-Am ProMount Steel 54" (137 cm) Blades).

Can-Am ProMount Blade Extensions

Maverick, Maverick MAX

■ 715004205 · Black
■ 715005319 · Yellow



- These conveniently extend your Can-Am ProMount Blade.
- Add 3" (8 cm) each side.
- Compatible with Can-Am ProMount Blades (except for the Can-Am ProMount Steel 54" (137 cm) Blades).
- Longer Wear Blade can be installed to go over the extra length given by the extensions.

Back Drag Blade

(Not illustrated)

ProMount Plows (60" and more)

715007794

- ¼ thick steel swivel scraper.
- Lifts up when the vehicle is moving forward so as not to affect the scraping.
- Increased capacity to pull snow.
- More aggressive scraping in reverse mode.
- Lifts the scraper off the ground so that it scrapes evenly.
- Adjustable in length for compatibility with 60", 66" and 72" blades.
- Compatible with ProMount blades (Flex and Steel).
- Not compatible with Backcountry Track Kit.

Curved Wear Blade

(Not illustrated)

Maverick, Maverick MAX

715007793 - 72" (183 cm)

- Wear blade designed with a folded back bottom lip.
- The increased surface allows for less digging while plowing uneven surfaces.
- Ideal for snow covered gravel, grass, paver stone and other soft surfaces.

Can-Am ProMount Custom Solutions

Can-Am ProMount Push Frame with Quick-Attach System

Maverick, Maverick MAX

715008116



- Heavy-duty steel tubes designed to withstand the roughest use.
- Mid-mount carriage provides ultimate push strength and traction.
- Designed for maximum plow lift height.
- Features a self-aligning quick-attach system, an easy foot release pedal and an ergonomic handle for plow angle adjustment.
- Plow Limit Switch recommended to extend winch cable lifespan.
- Can-Am ProMount Mounting Plate required for installation.
- Blade swivels left or right, 5 positions.
- Large pin designed for easy blade rotation to eliminate dirt and snow buildup at pivot point.
- Plow Roller Fairlead included.

Can-Am ProMount Push Frame Extension

Maverick, Maverick MAX

715006257



- 12" (30 cm) push frame extension required when plow is installed with Apache Track systems.

Can-Am ProMount Mounting Plate

Maverick, Maverick MAX

715008197



- Required to install the Can-Am ProMount Push Frame with Quick-Attach System.
- Mounting plate precision designed to stay on year round without compromising ground clearance.
- Comes with the Plow Roller Fairlead.
- Not compatible with S3 High Clearance Front A-Arm.

Can-Am ProMount Plow Angling System

Maverick, Maverick MAX

715009241



- Converts your plow system into an easy-to-control unit from the driver's seat.
- Allows you to have full up/down and left/right plow control at your fingertips with the supplied joystick.
- Using one hand to control all plow motions allows you to easily concentrate and manage your plowing tasks.
- Compatible with the SxS ProMount Push Frame and Blade.
- Not compatible with Apache Backcountry LT Track System.
- Push Frame Extension (715006257) is required for installation with the Front Rancher Bumper.
- Winch and plow sold separately.

ProMount Plow Limit Switch

(Not illustrated)

Maverick, Maverick MAX

715006259

- For controlling the cable tension when over-raising your plow system.
- Prevents winch, plow push frame and vehicle damage.
- Sensor relocated for optimal lift height.

Plow Roller Fairlead

Maverick, Maverick MAX

715001223

• Cylindrical Roller Fairlead



- Larger diameter lower roller reduces wear on wire rope for plow application.
- Can be used with all ProMount plows.

COVER & TRAILERING

Trailering Cover

(Not illustrated)

Maverick

715005813

Maverick MAX

715005814

- Heavy-duty canvas made of UV-resistant solution-dyed polyester.
- Inner soft liner protects windshield and colored panels from abrasion.
- All high-abrasion areas are reinforced with a double canvas layer.
- Weather-resistant trailering cover protects your vehicle during storage and transportation.
- Opening for fuel cap and cabin access on passenger side.
- Quick and easy installation.
- Designed to perfectly fit your vehicle with or without Can-Am accessories.

Bolt-On[†] Retractable Ratcheting Tie-Downs

295101072



- Perfect for transporting your powersport vehicle or securing loads.
- Mounts easily: bolts on any flat surface (e.g., truck bed or frame).
- 1" x 6' (2.5 cm x 1.8 m) tie-down strap with heavy-duty stitching that delivers a 500 lb (226 kg) working load strength and 1,500 lb (680 kg) break strength.
- Convenient retractable push button automatically slackens, spools and stores away strap, while the ratchet mechanism tightens the strap snugly to secure your vehicle or load into place.
- Rubber ratcheting handle provides firm grip, and the hook is vinyl coated to protect whatever surface it hooks into.
- Sold in pairs.

Ratchet Tie-Downs

715008309 · Black/Gray



- 400 lb (181 kg) safe working load.
- 1" x 10' (2.5 cm x 3 m) strap with Sea-Doo, Ski-Doo and Can-Am logos.
- Deluxe ratchet with rubber handle.
- Coated S hooks.
- Pack of 2.

Heavy-Duty Ratchet Tie-Down

715008308



- 1,000 lb (454 kg) safe working load.
- 1.5 in. x 6 in. (38 mm x 1.8 mm) strap with BRP brands.
- Deluxe ratchet with rubber handle.
- Black-coated clip hooks.
- 12" (300 mm) webbing included.
- Pack of two.



PARTS AND MAINTENANCE

Keep an Eye on These Parts	46
XPS Tires	47
XPS Oil & Oil Change Kits	48
Maintenance Products	49

A woman in a racing helmet is in the foreground, looking upwards. Another woman in a racing suit is in the background, also looking upwards. They are inside a vehicle, possibly a snowmobile or ATV, with a desert landscape visible through the windshield. The text is overlaid on the left side of the image.

BLENDING PERFORMANCE AND SAFETY

Trust genuine Can-Am parts to keep your vehicle performing at its best.

ONE-YEAR WARRANTY*

Precisely engineered. Rigorously tested. Factory approved.

*Covers parts and labor when fitted at an authorized dealer.

CAN-AM MAVERICK



To make sure your Maverick performs as you expect, **keep an eye on these components:****

OIL FILTER 420956123

ENGINE OIL *

4T 10W-50 Synthetic Oil

1 quart / 946 ml 9779234
1 US gallon / 3.785 L 9779235

4T 0W-40 Synthetic Oil

1 quart / 946 ml 9779139
1 US gallon / 3.785 L 9779140

4t 5W-40 Full Synthetic Oil

1 quart / 946 ml 9779492
1 US gallon / 3.785 L 9779493

OIL CHANGE KIT *

5W-40 Full Synthetic

900 ACE 9779489

10W-50 Synthetic Oil

900 ACE 9779261

EMISSION CONTROL

Fuel tank vent breather filter

(non EVAP models) 709001120

Canister vent pre-filter

(CARB and EVAP models) 513034047

AIR FILTER

Performance Air Filter

by Twin Air† 715002895

Premium Air Filter

715900422

CVT AIR FILTER

420450405

DRIVE BELT

422280652

BRAKE PAD KITS

Front brake pads

(4 pads + hardware) 703501198

Rear brake pads

(4 pads + hardware) 703501199

CV BOOT KITS

Rear Wheel & Differential Side 715900450

Front Wheel & Differential Side 705401354

WHEEL BEARINGS

293350151

BALL JOINTS

Upper

706203084

Lower

706202045

SPARK PLUG

415130363

BATTERY

18 Amps. Wet (YTX20L-BS)

296000444

*For Europe, please check correspondent PNs on page 48.

**Refer to periodic maintenance chart for proper intervals.

XPS TIRES

SHOP BY USAGE



GRAVEL &
HARD PACK



ROCK



MUD

XPS Trail Force



- All-terrain radial tire.
- 8-ply rated construction.
- Versatile and suitable for many types of terrain.
- Aggressive tread pattern for better traction on dirt, mud and rocky terrains.
- Tread depth: 20 mm (0.78").

705403026 · 26X8R14

705503322 · 26X10R14

705402754 · 27X9R14

705503103 · 27X11R14

XPS Trail King



- All-terrain radial tire.
- 8-ply rated construction.
- Aggressive tread pattern for tougher terrains.
- An almost continuous center tread offers a smoother trail ride.
- Tread depth: 26 mm (1.02").

705402713 · 26X8R12*

705503073 · 26X10R12*

705403081 · 27X9R14

*6 ply rating

705503355 · 27X11R14

705402825 · 28X9R14

705503181 · 28X11R14

XPS Trail King 2



- All-terrain radial tire.
- 6-ply rated construction.
- Tire excels in various terrains from loose to hard packed.
- Non directional tread pattern with optimized construction providing precision handling ensuring maximum grip and low rolling resistance
- Tread depth: 20 mm (0.78").

705403398 · 26X8R14

705503518 · 26X10R14

705403397 · 27X8R14

705503517 · 27X10R14

XPS Trac Force



- All-terrain light truck style radial tire.
- 8-ply rated construction.
- Central tread for good grip and comfort on compact terrain.
- Tread depth: 18 mm (0.71").

705403080 · 30X9R14

705403369 · 30X9R15

705503354 · 30X10R14

705403586 · 30X10R14 UT*

705403370 · 30X10R15

705403416 · 32X10R16 UT*

705403587 · 32X10R15 UT*

*6 ply rating

XPS Hammer Force



- Light truck-inspired tire.
- 8-ply rated construction.
- Rock-crawling tread pattern with unique contact patch.
- Aggressive sidewall for maximum traction when faced with technical terrains.
- Tread depth: 15 mm (0.59").

705402918 · 30X10R15

XPS Swamp Force



- Hybrid radial tire for mud and trail.
- 8-ply rated construction.
- Unique tread pattern allowing good grip in mud and mud ejection.
- Center tread provides for comfortable trail riding.
- Tread depth: 36-38 mm (1.41"-1.49").

705403201 · 30X9R14

705503387 · 30X11R14

XPS Swamp King



- Bias tires for mud and trail.
- 6-ply rated construction.
- Ultimate performance in mud without sacrificing good trail handling.
- Tread depth: 38 mm (1.49").

705403028 · 28X8X14

705503324 · 28X10X14

XPS Swamp King XL



- Bias ply for mud and trail
- 6-ply rated construction.
- Our best performing mud tire that does not compromise your trail riding
- Deep V grooved Lugs with extended shoulder tread for max traction in deep ruts that also help eject mud faster.
- Tread depth: 38 mm (1.49") center, max depth 52 mm (2.05").

705503687 · 30X9X14

705403381 · 30X10X14

LUBRICANT & OIL CHANGE KIT

Lubricant

XPS 4T 10W-50 Synthetic Oil

9779234 (US) · 1 qt / 946 ml
9779240 (Europe) · 1 qt / 946 ml

9779235 · 1 US gal / 3.785 L



- Engineered for heavy-duty and high-performance 4-stroke engines, including turbocharged, supercharged and racing engines.
- Formulated using carefully selected and strenuously tested base stocks and custom additives.
- Offers thick film strength to protect bearings, and a proven high-temp detergency to minimize deposits, prevent shear, provide thermal stability, and combat fuel dilution to ensure maximum performance from your engine.

XPS 4T 0W-40 Synthetic Oil

9779139 (US) · 1 qt / 946 ml
9779286 (Europe) · 1 qt / 946 ml

9779140 (US) · 1 US gal / 3.785 L
9779287 (Europe) · 1 US gal / 3.785 L



- Powersport formula with premium anti-wear and anti-corrosion additives.
- The best choice for high-performance snowmobile, ATV and SXS 4-stroke engines used in cold weather.
- Provides superior engine and transmission protection against heat, rust and corrosion.
- Delivers optimal performance in high and low temperatures.

XPS 4T 5W-40 Synthetic Oil

9779492 (US) · 1 qt / 946 ml
9779900 (Europe) · 1 qt / 946 ml

9779493 (US) · 1 US gal / 3.785 L
9779901 (Europe) · 1 US gal / 3.785 L



- Off-road formula with premium anti-wear and anti-corrosion additives.
- Designed for high-performance off-road, on-road and PWC 4-stroke engines, including turbo or supercharged powersports engines.
- Provides superior engine and transmission protection against rust and corrosion, even in extreme conditions.

Oil Change Kit

Engine Oil Change Kit

Models



- Ultra-convenient "all-in-one" Engine Oil Change Kit saves time and money.
- Includes XPS Synthetic or Synthetic Blend Oil, oil filter, O-rings and washer.

5W-40 Synthetic Oil / 450 cc or less	9779487 (US) 9779954 (Europe)
0W-40 Synthetic Oil / 450 cc or less	9779257 (US) 9779409 (Europe)
5W-40 Synthetic Oil / 500 cc or more V-twin engine	9779488 (US) 9779953 (Europe)
0W-40 Synthetic Oil / 500 cc or more V-twin engine	9779259 (US) 9779406 (Europe)
10W-50 Synthetic Oil / 500 cc or more V-twin engine	9779252 (US) 9779401 (Europe)
0W-40 Synthetic Oil / 650 ACE	9779481 (US) 9779417 (Europe)
5W-40 Synthetic Blend Oil / 650 ACE	9779480 (US) 9779952 (Europe)
5W-40 Synthetic Oil / 900 ACE	9779489 (US) 9779955 (Europe)
10W-50 Synthetic Oil / 900 ACE	9779261 (US) 9779411 (Europe)
5W-40 Synthetic Oil / 999T	9779500 (US) 9779959 (Europe)
10W-50 Synthetic Oil / 999T	9779501 (US) 9779960 (Europe)

MAINTENANCE PRODUCTS

Synthetic Gear Oil	75W-90	9779158 (US) · 1 qt / 946 ml 9779212 (Europe) · 1 qt / 946 ml
	75W-140	9779160 (US) · 1 qt / 946 ml 9779215 (Europe) · 1 qt / 946 ml



- Uses custom additives to provide the best performance in Visco-Lok™ and Smart-Lok™ differentials.
- Allows higher loads, superior shear stability and reduced oxidation.
- Exceptional wear protection and superior performance at all operating temperatures.

XPS Synthetic DCT Fluid <i>(Not illustrated)</i>	9779710 (US) · 1 qt / 946 ml 9779473 (Europe) · 1 qt / 946 ml
--	--



- Meets or exceeds API GL-4 industry specifications.
- Formulated for dual clutch system.
- Enhanced cooling capabilities for optimal clutch functionality.
- Anti foaming agents for smooth hydraulic function.

Extended Life Pre-Mixed Coolant	9779150 · 1 qt / 946 ml 619590728 (Scandinavia) · 1 qt / 946 ml
--	--



- Antifreeze/coolant contains the correct dilution and the necessary additives to prevent corrosion and inhibit cavitation in BRP cooling systems.
- Long-life, 5-year formula specially formulated for BRP vehicles.
- Superior heat transfer.
- Ideal replacement for vehicles that normally use a 2-year antifreeze/coolant (green).
- 5 years (orange).

Anti-Corrosive Lubricant	9779701 · 120 oz / 340 g 619590733 (Scandinavia) · 120 oz / 340 g
---------------------------------	--



- Multipurpose lubricant that can also be used to prevent rust, corrosion and moisture intrusion.
- It contains extreme pressure additives that work as an all-around lubricant for just about anywhere lubrication is needed.

Extreme Duty Suspension Grease	9779708 · 14 oz / 400 g
---------------------------------------	--------------------------------



- Designed to work specifically with the components found in Can-Am vehicle suspensions.
- It is highly stable and offers optimal lubrication at both extreme cold and high temperatures while protecting suspension components from dirt and moisture, as well as corrosion under extreme washout conditions.

XPS Spline Grease <i>(Not illustrated)</i>	9779704 (US) · 4 oz / 115 g 9779472 (Europe) · 4 oz / 115 g
--	--

- Enhanced rust and corrosion resistance.
- Protects against seizure, heat-freeze, galling, rust and corrosion.

DOT 4 Brake Fluid**9779151** (US) · 12 fl. oz. / 355 ml
9779207 (Europe) · 12 fl. oz. / 355 ml

- Meets or exceeds all DOT3 and DOT4 brake fluid requirements.
- High-temperature formula resists fade and also conditions seals and O-rings in braking system.

Racing Brake Fluid RS600**9779171** (US) · 12 fl. oz. / 355 ml
9779183 (Europe) · 12 fl. oz. / 355 ml

- Exceeds DOT4 brake fluid requirements for extreme conditions and competition use.
- Extreme, 579-degree boiling point temperature is ideal for high-demand competition conditions to combat brake fade.
- Will not harm seals or braking system components.
- Should be added only to a clean/unfilled system to avoid dilution and diminished performance.
- Low-moisture formula slows water vapor absorption through multiple heat cycles.
- Recommended for use in Ski-Doo and Can-Am racing applications.

Fuel Stabilizer**9779171** · 8 fl. oz. / 236 ml

- Ethanol-compatible and will stabilize fuel in your tank to keep it from breaking down and causing hard starting, throttle hesitation and poor run quality.
- Since ethanol attracts moisture, this product contains powerful anti-corrosion additives to protect fuel system components.
- Prevents problems associated with E10 fuels.



BRP REIMAGINES THE WAY YOU ACCESS YOUR WORLD

Can-Am is one of many success stories from BRP, the global company behind some of the most daringly innovative products and experiences that move you. Because it's not about the destination, it's about the journey — yours.

Discover our brands:

ski-doo **LYNX** **SEA-DOO** **can-am** **ROTAX** **ALUMACraft** **MANITOU** **QUINTREX**

www.brp.com

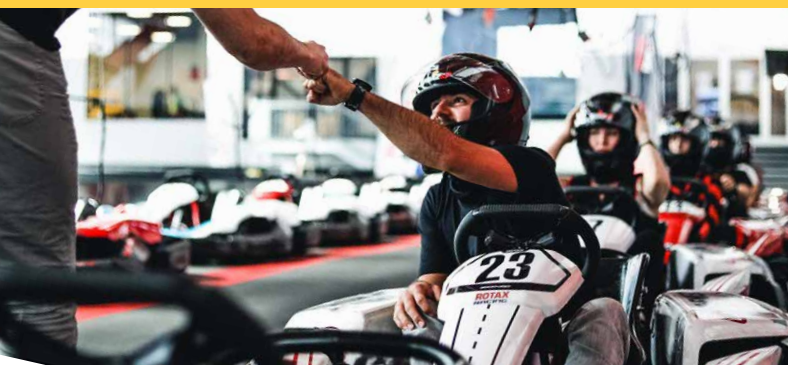



CANAMOFFROAD.COM

